



[www.probbax.com](http://www.probbax.com)

# PRODUCT CATALOGUE

# 2024



**INDOOR AND OUTDOOR WASTE MANAGEMENT • SELECTIVE WASTE MANAGEMENT**  
**• FOOD SERVICE EQUIPMENT • SANITARY EQUIPMENT**

# COMPANY PRESENTATION

Since its **creation in 2005**, Probbax® has invested not only in the development of **sustainable, high performance products** for end customers, but also in long term, balanced relationships with its **commercial partners**. Now represented in over **35 countries** around the world, the Probbax® brand is trusted both for the **quality** of its products and for the **reliability** of its customer service. An **experienced team**, attentive to trends and needs, that provides solutions to companies willing to implement effective **waste sorting** and collection for their staff, individually or collectively.

# SUMMARY

**Outdoor**  
Waste management

**3-16**

**Indoor**  
Waste management

**17-26**

**Selective**  
Waste management

**27-40**

**Food service**  
Equipment

**41-44**

**Sanitary**  
Equipment

**45-48**

# CSR COMMITMENTS

MANUFACTURE → USE → REUSE

↑ RECYCLE ← RETRANSFORM ↓



Reciprocity



Workers protection



Waste reduction



Certifications



Quality follow up



Respect



Payments terms



Supplier probity



Durability



Partnerships



Confidentiality



Recyclability

# MATERIALS

50% TO 100% RECYCLED AND UP TO 100% RECYCLABLE

## PLASTICS

POLYPROPYLENE • PMMA • ABS

**Recycled, recyclable and recoverable**

Often mixed with virgin material in order to preserve certain properties such as colours

## METAL

ALUMINIUM • STAINLESS STEEL • GALVANISED STEEL

**100% recyclable ad infinitum without loss of properties**

## ALLOY

ALUMINIUM + POLYETHYLENE

**Recycled, retransformable and reusable without loss of properties**

## CARDBOARD Packaging

**Made of recycled and recyclable material, from sustainable FSC forests**



EXPLORE OUR PRODUCTS IN THIS BROCHURE OR ONLINE

### TAILOR MADE SORTING STATIONS

CONFIGURE A BESPOKE SORTING STATION AND PRINT CUSTOMISED SORTING INSTRUCTIONS (A4 FORMAT)

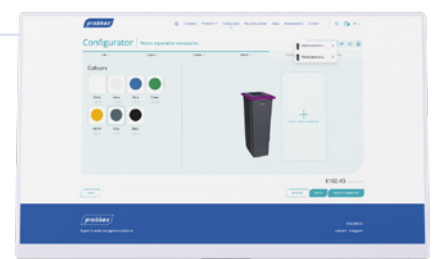

WWW.PROBBAX.COM





## Outdoor Waste management

**6-8.** Wall-mounted solutions

**12-13.** Bin + Ashtray combinaisons

**9-11.** Stand alone ashtrays

**14-16.** Outdoor selective waste collection

# PROBBAX® ADDED VALUE

Probbax® ashtrays solutions to tackle the most common issues

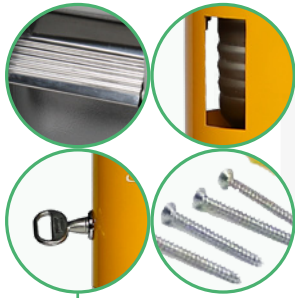

■ Rusted parts or screws and peeled off paint staining the walls.

+ **Stainless steel** snuff plate, screws and lock.

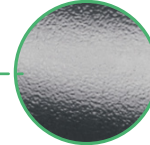

■ Smooth surface: highly visible marks and scratches.

+ **Non marking textured surfaces.**



■ Stagnating rainwater causing dirt and rust.  
Sharp edges: potential safety hazard, tearing off of clothes/ uniforms.

+ **Rainwater drains. Rounded edges.**



■ Long smoke emissions.

+ **Integrated funnels** significantly reduce air supply and thus smoke emissions and the risk of smoke emissions.



■ One proprietary key per ashtray = too many keys to carry and manage.

+ **One key fits all** Probbax® ashtrays.



■ Complicated to empty: contents falling on the floor.

+ **Inside liners** are time saving, hygienic, easy to remove and to empty.



■ No spare parts available: one must purchase a full new product everytime a part is damaged.

+ **Keys, bodies, bases are all available as spare parts** for an increased product life span.

■ No instructions, no hardware resulting in loss of time and extra costs.

+ **It's all in the box:** Instructions, wall-mounting template, all necessary hardware and key.



# 7,7 BILLION

non bio-degradable cigarette butts are thrown away in nature every year. They represent:

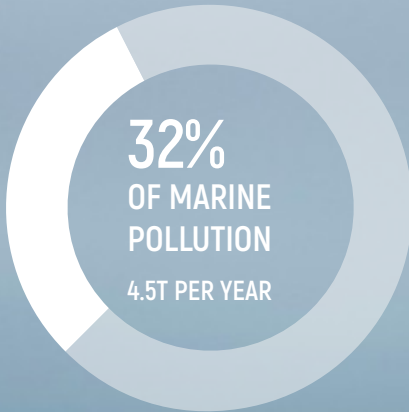

1 CIGARETTE BUTT  
=  
7000 CHEMICALS  
500L OF POLLUTED WATER



Sources : ademe.fr, The Guardian, Préfecture du Var, L'Indépendant.

## BEACH ASHTRAY

Polypropylene

Lighweight,  
heavy-duty, fire  
and UV resistant



AT-0990-DGRY

More on  
this product  
page 11

## NEW POCKET ASHTRAY

Aluminium

Take it along in the car, in the woods,  
on the beach, etc.

- Easy to attach to keys, bags or trousers thanks to the snap hook.
- Ideal for disposing of cigarette butts in areas where there are no outdoor ashtrays.
- Holds odours and up to 4 cigarette butts.
- Easy to empty and clean thanks to the unscrewable base.



AT-0030-ALU

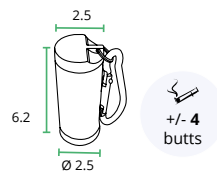

AT-0030



# WALL-MOUNTED SOLUTIONS

## ROUND Epoxy

### Cost-effective solution for collecting cigarette butts.

Ideally suited to protected outdoor environments • Galvanised steel with UV-resistant epoxy coating • Supplied assembled  
• Wall-mounting kit provided for quick installation.

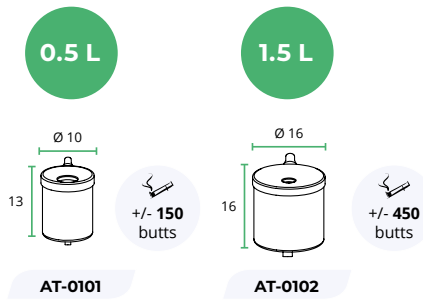

## ANTI-VANDALISM Epoxy • Stainless steel 304

### Robust solutions for collecting cigarette butts.

Shallow ashtrays with rounded lines • Dark grey versions with anti-UV treatment • Supplied assembled with removable inside liner, locking key, wall-mounting template and screw kit.

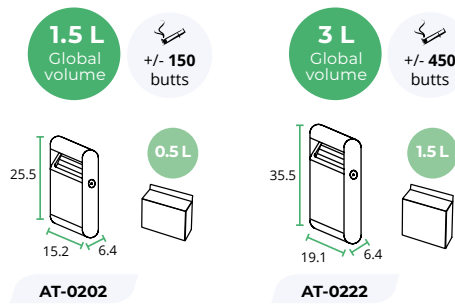

Wall-mounting kit, key and removable liner included



AT-0222-DGRY

## 2 IN 1 Epoxy • Stainless steel 304

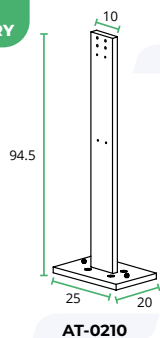
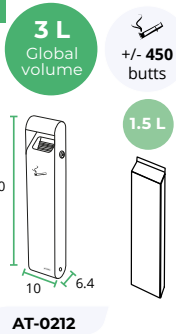

Wall-mounting kit, key and removable liner included



Full kit  
page 11

AT-0213





## WITH ROOF **Stainless steel 304**

### Ashtray with a timeless design.

All stainless steel ashtray • Roof protects contents from rainwater • Quick and easy to install • Screws, locking key and assembly template included.



AT-0403-MSSTL

1.7 L

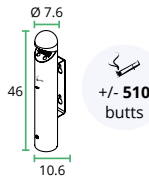

AT-0403



Locked hatch for emptying from underneath



AT-0403-MSSTL

## DOME **Epoxy • Stainless steel 304**

### Efficient and discreet wall-mounted ashtrays.

Robust stainless steel construction • Reduces rain infiltration • With interior funnel to quickly smother smoke emissions • Quick and practical wall-mounting with the included hardware and template • Available in 2 finishes.



AT-0291-MSSTL AT-0291-DGRY

1.8 L

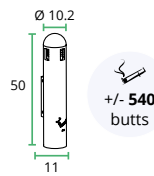

AT-0291



Easy emptying from the bottom



AT-0291-DGRY

## DOME **Aluminium**

### Elegant and suitable for all smoking areas.

Highly resistant to rust • Particularly recommended for use by the sea • Quick and easy to install with the wall-mounting kit and installation template included • Supplied with a key.



AT-0303-ALU

1.4 L

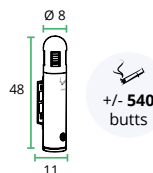

AT-0303



Easy emptying from the bottom



AT-0303-ALU

NEW



## HALF ROUND Epoxy

**Under a porch or near an entrance.**

Sleek design and rounded edges • For indoor or outdoor installation • UV-resistant coating, bag holder and stainless steel screws • Contact-free waste disposal • Supplied with wall mounting template and stainless steel screws • The bag holder ensures a clean appearance and easy maintenance.

**WM-3021-DGRY**  
**WM-3041-DGRY**

**20 L**  
35 19 49.5

**40 L**  
40 21.5 66

**WM-3021** **WM-3041**

Integrated bag holder

White version  
page 20

Small footprint

**WM-3041-DGRY**

## ASH & TRASH Epoxy

**Very robust. Small depth but large capacity.**

Effective combination for collecting cigarette butts and small waste • Particularly suitable for areas where floor mounting is not permitted • UV-treated epoxy coating • Stainless steel parts and screws • Key, hardware and assembly template included.

**AT-0252-DGRY**

**AT-0252**

+/- 900 butts

3 L  
14 L

67 30 14

Drawer-ashtray

Tilt the waste compartment to empty it

Stainless steel lock





# STAND ALONE ASHTRAYS



NEW • JULY 2024

## DOME XL Epoxy • Stainless steel 304

### New high-capacity variant.

With integrated funnel and removable inside liner • Available in 3 finishes: satin stainless steel, grey epoxy or a mix of the two • Floor-mounted • Optional weight.

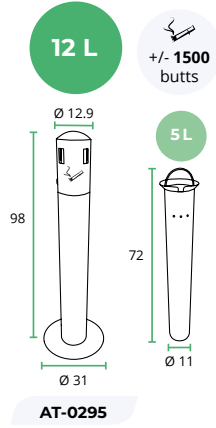

## WEIGHT Polypropylene

Optional weight • Compatible with floor mounting.

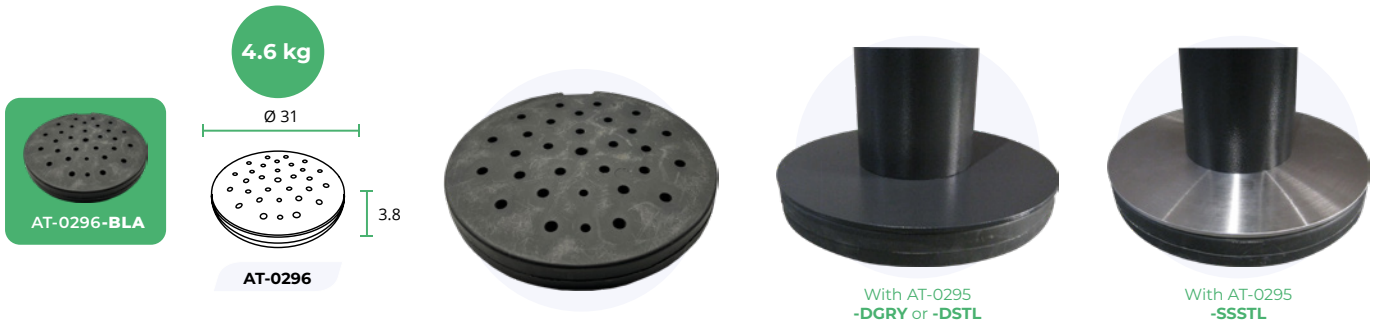

AT-0295-DGRY

**DOME** Epoxy • Stainless steel 304

**Often used on terraces or at building entrances.**

With removable inside liner • Anti-rust and anti-UV coating • Ballasted base • Anti-smoke funnel • 4 access points.

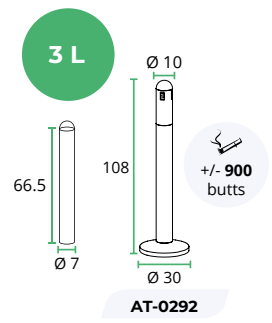

Snuff plate accessible from 4 sides      Removable cover for easy access to the inside liner      2.5L removable inside liner with handle

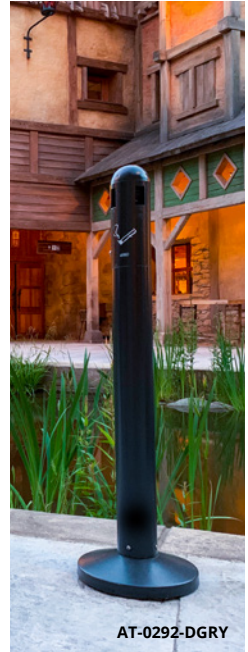

AT-0292-DGRY

**Aluminium**

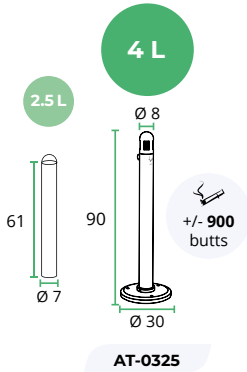

2.5L removable inside liner with handle



AT-0325-ALU

**WITH ROOF** Stainless steel 304

**Contemporary design for a sleek ashtray.**

All stainless steel construction • Design with roof to protect contents from rainwater • Weighted lower section • Quick and easy to install • Supplied ready to use with key and ground fixing kit.

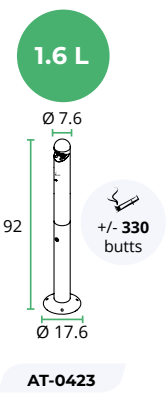

Hatch halfway up the upper part of the body for emptying



AT-0423-MSSTL





## COMPACT Epoxy/Stainless steel 304 • Epoxy

### Compact but effective solution.

Free-standing version of the AT-0212 slim wall-mounted ashtray.

Combination of an ashtray ref. AT-0212 and an AT-0210 post (see page 6) • The base must be fixed to the floor • Floor fixing kit, inner liner and key included.

3 L Global volume  
+/- 450 butts  
1.5 L

100  
25  
20

AT-0213

AT-0213-SSDG AT-0213-DGRY

Easy access to inside liner

AT-0213-DGRY

## FIREPROOF Polypropylene V2 certification

### Ideal for open-air hospitality, seafronts, etc.

Weatherproof, UV and impact resistant • Perennial colour • Supplied with a removable 10-litre galvanised inner bucket • Stainless steel snuff plate • Tool-free assembly for quick and easy installation.

10 L  
+/- 2000 butts

95  
14  
Ø 10  
Ø 35.8  
Ø 24.2  
32.8  
22  
Ø 16.2

AT-0990

AT-0990-DGRY

Can also be fixed to the ground to prevent theft

Lockable (lock not included)

Equipped with a removable inner bucket

AT-0990-DGRY

## “TOTEM” Epoxy

### Recommended for high-traffic areas.

Very sturdy, large-capacity stand alone ashtray • Removable inner liner • Key lock (included) • Made of galvanised steel with anti-UV epoxy coating • Stainless steel snuff plates accessible from both sides of the ashtray • Very stable thanks to its concrete base • Easy to assemble with the included assembly kit and ground fixing kit.

12.5 L  
+/- 3750 butts

104  
65.6  
40  
26  
11  
16.5

AT-0232

AT-0232-DGRY

Built-in funnel smothers cigarette butts to prevent long-lasting emissions of smoke

No tilting required to open and empty

AT-0232-DGRY

# BIN + ASHTRAY COMBINAISONS

## CLASSIC Stainless steel 304 • Epoxy

**For indoor and covered outdoor sites.**

Smooth surface, easy to clean and maintain • Inner bin accessible by lifting the aluminium ashtray.

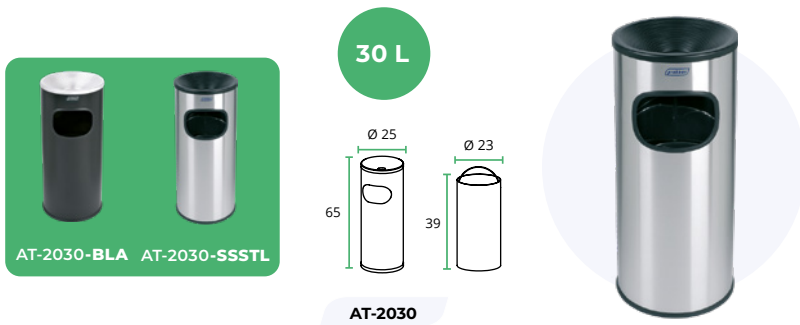

## ASHTRAY WITH BIN Epoxy

**Compact, very robust combination.**

Recommended for high-traffic areas • 2 removable inner liners • Easy emptying from the side of the container (key included)  
 • Galvanised steel with anti-UV epoxy coating • Stainless steel snuff plates are accessible from the front and rear of the ashtray  
 • Ballasted concrete base • Easy to assemble with assembly kit and ground fixing kit included.

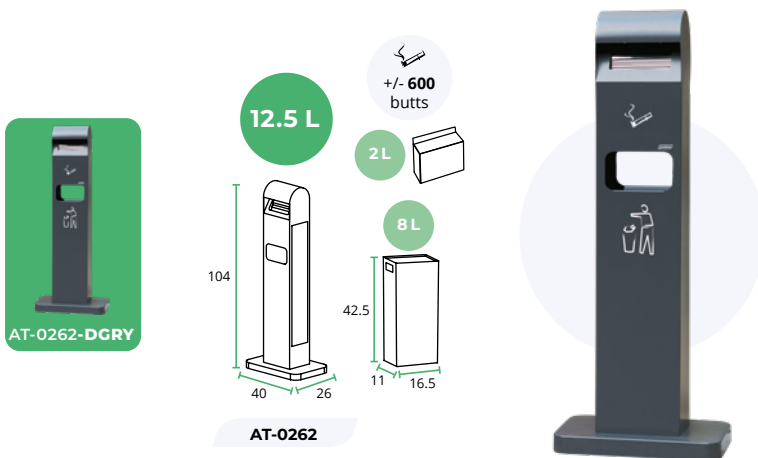

PROBBAX  
 ADDED VALUE  
page 4





# CONTAINERS WITH ASHTRAY

Epoxy

## Recommended for high-traffic areas.

Separate collection of cigarettes and waste • Access from both sides for extinguishing butts and disposing of waste • Robust galvanised steel construction with anti-UV epoxy finish • Stainless steel screws and lock • Delivered assembled with floor fixing kit • Easy maintenance: removable inner bins for quick, clean emptying. Key included.

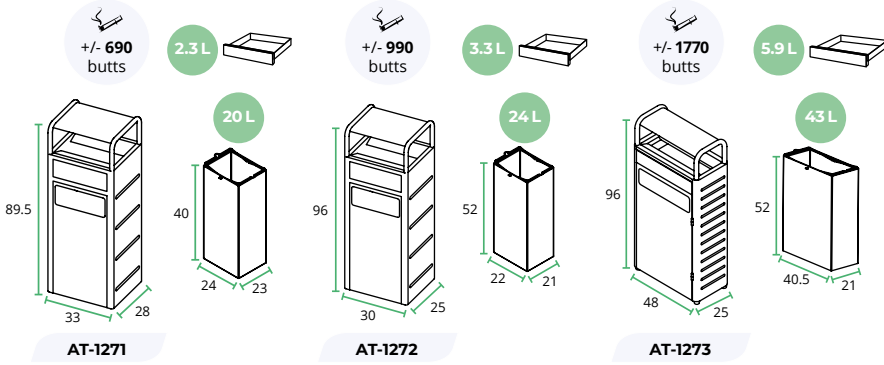

Epoxy

## Combined collection of cigarette butts and litter.

Integrated funnel with removable galvanised steel inner liners • Delivered assembled with floor fixing kit • Easy maintenance: key included • Stainless steel snuff plates and lock • Access from both sides to extinguish butts • Quick, clean emptying.

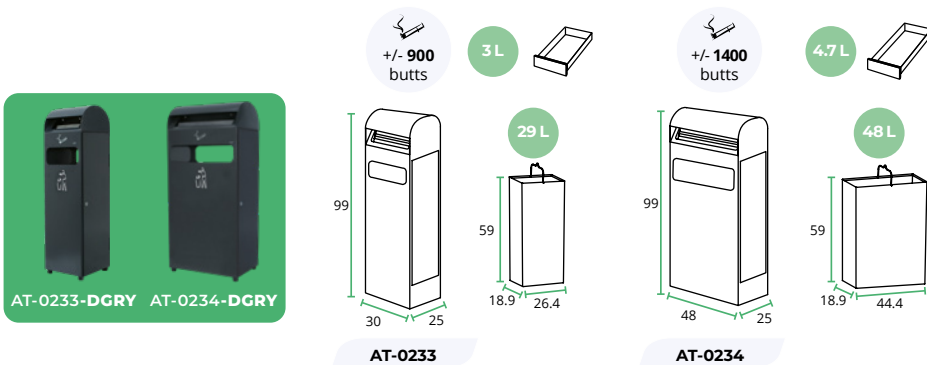

NEW

# OUTDOOR SELECTIVE WASTE COLLECTION

## WASTE STATIONS

Recycled food bricks



New stations made from an alloy of aluminium and plastic from recycled food packagings.

Manufactured in Europe in a solidary workshop - Low CO<sup>2</sup> footprint - Robust and durable - 3 variants available - 1 stream with roof, 2 streams and 3 streams - Can be fixed to the ground - Lockable door - For combination with the 80L Probbax® recycling bins that come in a choice of colours for convenient and hygienic waste collection and maintenance.



- WEATHER RESISTANT
- TOUCH FREE
- INCLUSIVE
- UV RESISTANT
- MAINTENANCE FREE
- NON TOXIC
- NON CONDUCTIVE
- NON PUTRESCIBLE
- HEAVY-DUTY
- RECYCLABLE

Door impossible to unhinge

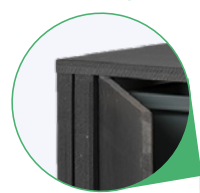

Fast removal of contents



Lockable

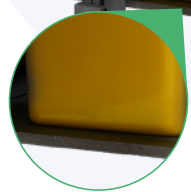

Anti-pest design

4 shock-resistant side panels

NEW MATERIAL MADE OF RECYCLED FOOD BRICKS

CARTON  
POLYETHYLENE  
ALUMINIUM

Aluminium + Polyethylene = INNOVATIVE Material



More details about recycling containers 80L [pages 34-35](#)





WS-0121-CBLA

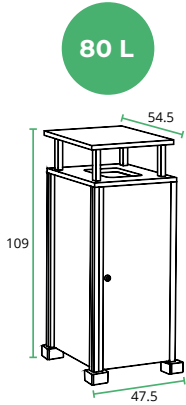

WS-0121

80 L



= 4950 Recycled food bricks



WS-0112-CBLA

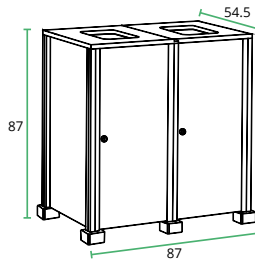

WS-0112

160 L



= 6715 Recycled food bricks



WS-0113-CBLA

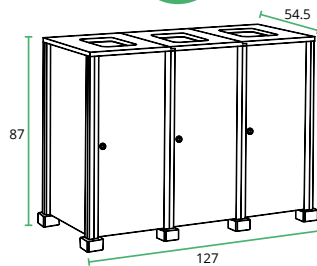

WS-0113

240 L



= 9605 Recycled food bricks



## ACCESSORIES FOR WASTE STATIONS Stainless steel 15/10

### Metal sorting plates to fix on top of the openings of the stations.

Choice of a plate with a round opening, or with a round opening + slot and a lid with hinge and handle. It is possible to combine a plate with a lid WS-0103.

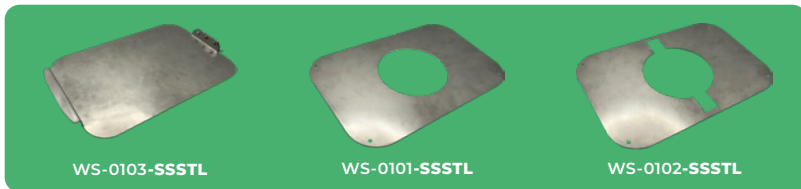
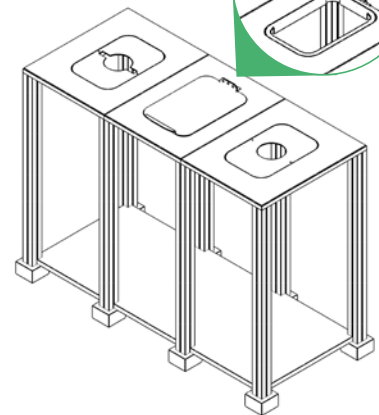
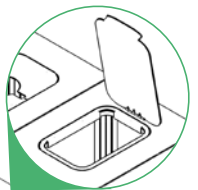

WS-0103-SSSTL

WS-0101-SSSTL

WS-0102-SSSTL

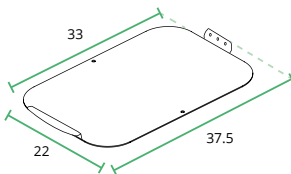

WS-0103

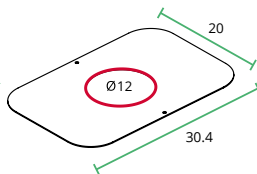

WS-0101

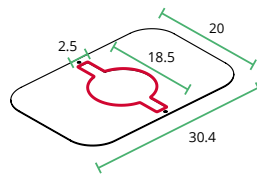

WS-0102



Compatible stickers **page 53**

# MODULAR OUTDOOR BAG HOLDER Recycled food bricks /polyethylene

Modular bag-holder system to combine with a number of accessories depending on the needs: from 1 to 3 streams. For wall or post mounting, with or without foot. Made from 75% recycled material.

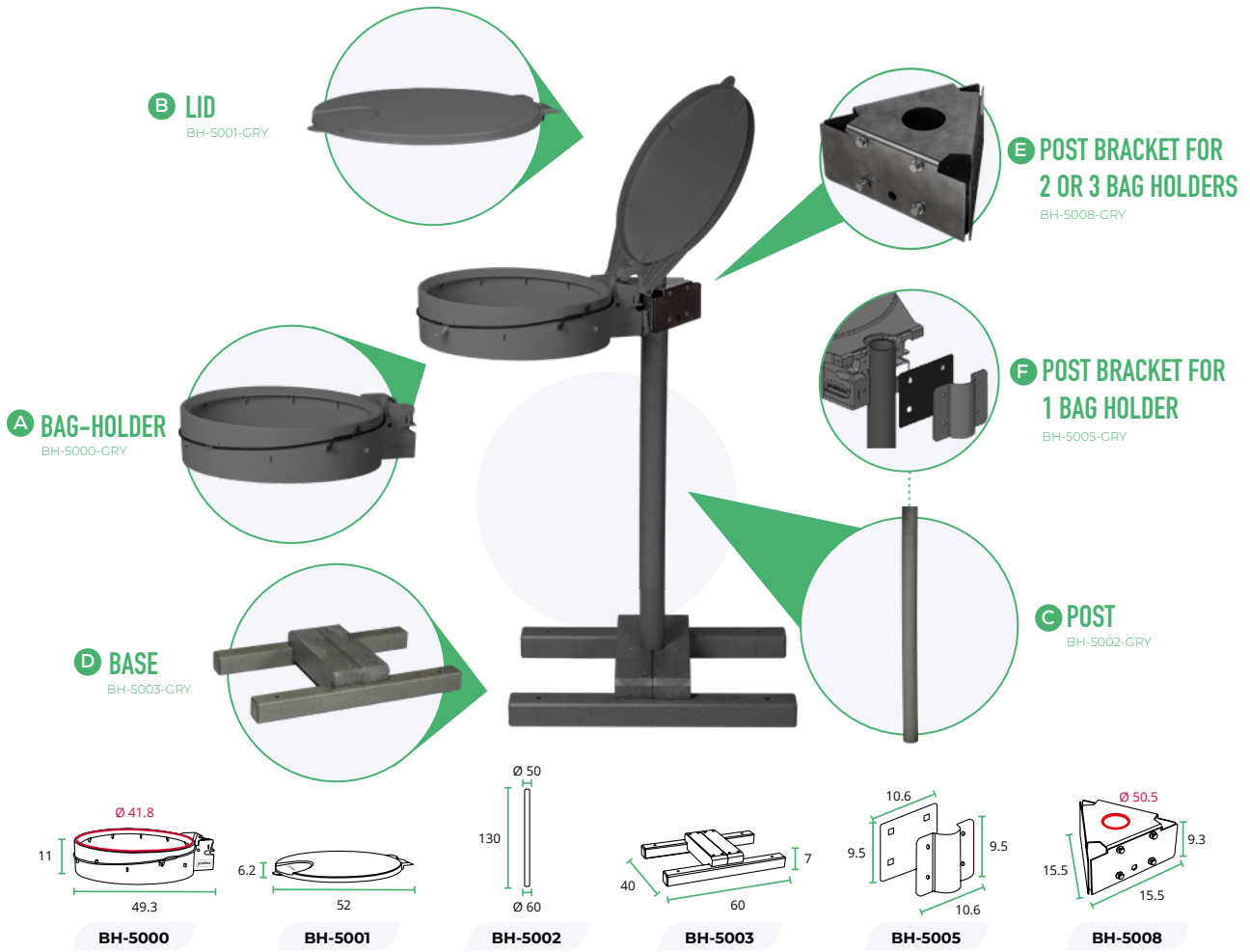

↓ 1 stream



**A**



**A + B**



**A + B + C + E**

## VARIANTS FOR WASTE SORTING

↕ 2 streams OR ↕ 3 streams



**A x2 + B x2 + C + E**



Compatible sticker sheet  
**page 53**

**STICKER-SHEET1**





## **Indoor** Waste management

**18-19.** Waste bins and baskets

**24-25.** Lobby bins

**20.** Wall-mounted bins

**26.** Round containers

**21-23.** Step-on bins

## BINS AND BASKETS

### CLASSIC BASKETS Recycled polypropylene

**Sturdy and easy to clean, ideal for use at the foot of a desk.**

Durable plastic construction, resistant to impact, rust and scratches.

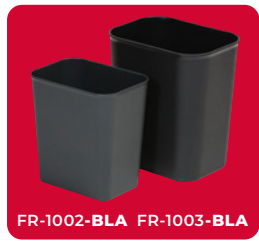

FR-1002-BLA FR-1003-BLA

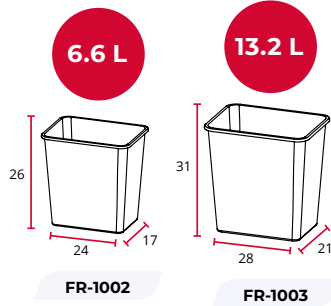

FR-1002

FR-1003



FR-1113-DGRY

### FIRE RESISTANT BASKETS Fireproof polypropylene

**Ideal for offices and hotel rooms.**

Made from flame-retardant plastic: if the contents catch fire, the bin material will inhibit the spread. Sleek design blends effortlessly into any environment.



FR-1112-DGRY FR-1113-DGRY

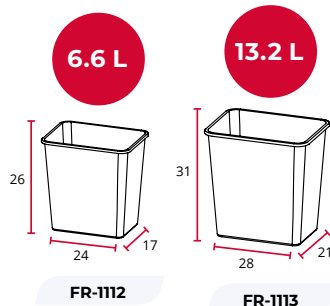

FR-1112

FR-1113



### FAUX LEATHER BASKETS Epoxy / PVC

**Leatherlike finish for a chic look.**

The bottom edge with rubber rim protects the bin from chemicals and the floor from scratches. A stainless steel ring around the top edge also gives this basket an elegant finish.



WB-1042-BLA WB-1042-BRN

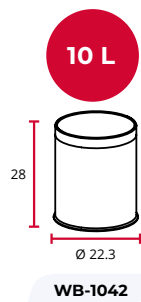

WB-1042



WB-1042-BLA

### DOUBLE-WALL BASKETS Epoxy • Stainless steel 18/0

**A practical and stylish waste bin, very popular with hoteliers.**

Unique design conceals the waste bag while keeping it in place. Available in 3 colours and 2 materials, the bin features a rubber ring at the base and a stainless steel ring around the top edge for a neat finish.



WB-1051-BLA WB-1051-BEI WB-1051-SSSTL

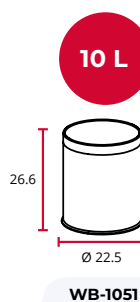

WB-1051



Completely conceals the waste bag for a clean, minimalist look



WB-1051-SSSTL



## SIMPLE BIN Polypropylene

**A simple, lightweight bin.**

Versatile light grey plastic bin without lid.



WB-0125-GRY

25 L

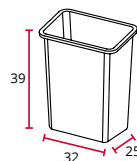

WB-0125



## ECONOMICAL BINS Recycled polypropylene

**Cost effective solution for a variety of environments.**

Tilting lid for quick waste disposal. Multi-purpose bins for offices, hotels, campsites, toilets, sports halls, etc. 100% recycled material.



ST-0210-GRY ST-0210-WHT  
ST-0225-GRY ST-0225-WHT  
ST-0250-GRY ST-0250-WHT

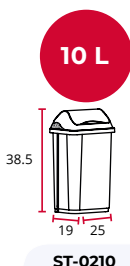

10 L

ST-0210

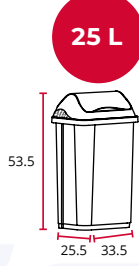

25 L

ST-0225



50 L

ST-0250



Only grey version



## ROBUST BINS Epoxy · Polypropylene

**Versatile containers for narrow spaces.**

Available in grey, white or black. Flap lids (PB-1121) for use across the width. Hinged lids (PB-1122) for use in depth or width. Wall-mounting possible with both types of lids.

20 L

Containers with lid



PB-1320-WHT

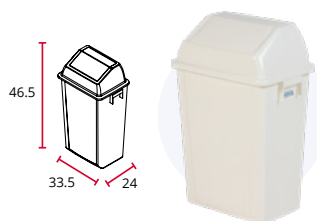

40 L

Containers



PB-1140-GRY PB-1140-WHT

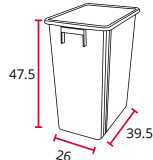

PB-1140-BLA



Lids for PB-1140



PB-1121-GRY PB-1121-WHT

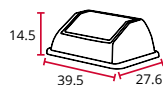

PB-1122-BLA

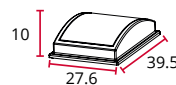

More swing lids for 40L black container in Selective waste collection category [page 31](#)

PB-1122



See next page All kits containing 1 bin + 1 lid + 1 wall bracket + screws [next page](#)

Wall bracket for PB-1140 and PB-1120



PB-1105-DGRY

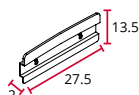

# WALL MOUNTED BINS

## FULL KITS Polypropylene • metal

**Ready to install: Bin + lid + wall bracket + screws.**

The hinged lid is detachable and the container with lid fits perfectly flush to a wall. Easy to install: fix the bracket to the wall, then the top rim of the bin snaps onto the bracket.

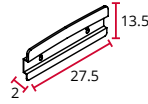
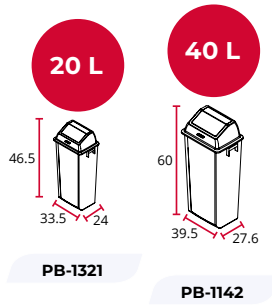

Included in ref. PB-1321 and PB-1142



### Kit composition



### Back view

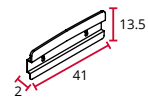
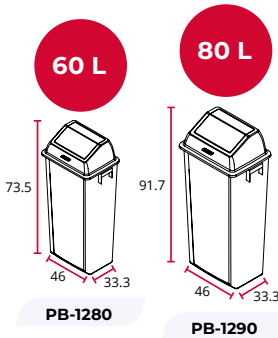
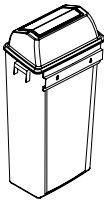

Included in ref. PB-1280 and PB-1290

More bins, lids and accessories in Mix & Match range [pages 34-35](#)



## HALF ROUND Epoxy

**Often installed in away-from-home washrooms, changing rooms, schools, fitness clubs, etc.**

Sleek design with rounded edges. Fitted with a stainless steel bag holder for a clean look and easy maintenance. Grip handle on the front and underneath the container for easy removal. Supplied with a wall-mounting template and all the necessary hardware for rapid installation.

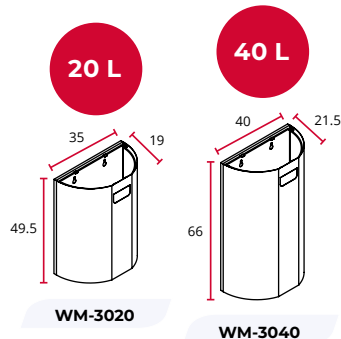



# PEDAL BINS

**CLASSIC** Epoxy • Stainless steel 18/0



**3 colours, 5 capacities, 2 materials.**

Fitted with a removable plastic inner liner with handle. Robust pedal with metal parts for longer lifespan. SO-6205-SSSTL has a domed lid and a wider non-slip base.

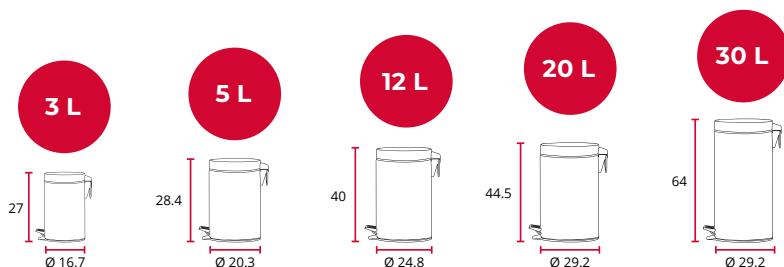

SO-6003-MBLA

SO-6005-MBLA

SO-6030-MBLA



SO-6003-MSSTL

SO-6005-MSSTL

SO-6012-MSSTL

SO-6020-MSSTL

SO-6030-MSSTL



SO-6003-WHT

SO-6005-WHT

SO-6012-WHT

SO-6020-WHT

SO-6030-WHT

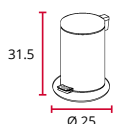

5 L

SO-6205-SSSTL



SO-6030-MBLA



SO-6005-MSSTL



Inside liner with handle included

## COLOUR REFERENCES

-MBLA MAT BLACK -MSSTL MIRROR STAINLESS STEEL -WHT WHITE

## ANTIBACTERIAL Recycled polypropylene

**Popular with catering and healthcare professionals for disposing of waste without touching the bin.**

This black version of the Probbax® recycled plastic pedal bin is infused throughout with a silver ion agent that inhibits the proliferation of viruses and bacteria. Stable over time, this antimicrobial and antibacterial property does not degrade during cleaning and disinfection operations and is compatible with HACCP protocols.

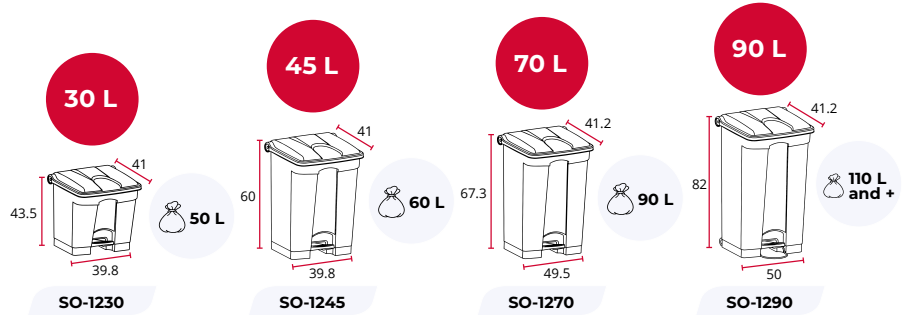

## WASTE SEPARATION STICKERS INCLUDED

Associate a type a waste to each bin. Each bin is delivered with a set of 6 sorting stickers.



Only 90L containers are fitted with 2 back wheels to ease handling

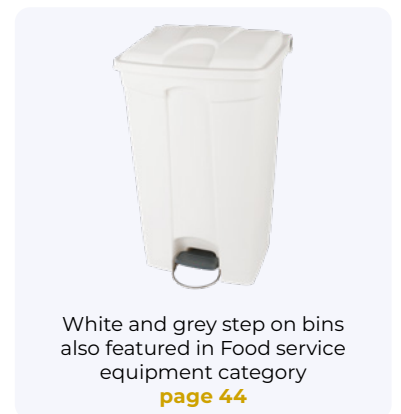



## MOBILE STEP ON Polyethylene/Polypropylene

**Container approved for food contact, highly appreciated in professional kitchens. (EN840)**

Equipped with a wide foot pedal for hygienic touchless operation. Large wheels and a rear handle make it easy to manoeuvre and transport. Durable plastic and metal construction withstands impacts, stains and temperatures ranging from -60° C to + 120° C\*.

\* If stored at -60°C, wait for the container to return to room temperature before use.



SO-1120-WHT

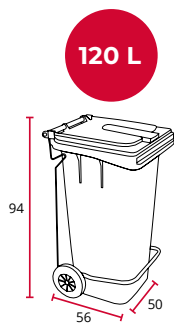

SO-1120



## BAG HOLDERS Stainless steel 201/Stainless steel 304

**A lightweight, robust and efficient solution.**

Appreciated for their ease of use and maintenance. Particularly suitable for food preparation areas, para-medical, medical or industrial sectors. Pedal operation to open the rubber clamp on which the bag is securely maintained in place with a rubber strip.



SO-2104-MSSTL SO-3104-MSSTL SO-3105-MSSTL

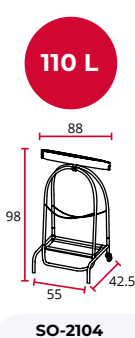

SO-2104

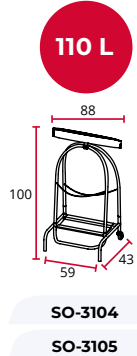

SO-3104

SO-3105



SO-3104-MSSTL



SO-2104

2 regular wheels



SO-3104

2 rubber wheels with breaks, dia. 8cm



SO-3105

4 rubber wheels with breaks, dia. 8cm



Side arches and retention platform

Products of this page are also in the Food service section of this brochure [page 43](#)



# LOBBY BINS

## MODULAR & FIRE-RESISTANT

Epoxy • Stainless steel 201



### Aesthetic fire-resistant containers compatible with selective collection.

This modular Probbax® concept is made up of 2 container shapes that can be installed on their own or in combination. TÜV fire certification thanks to the inner bins. Choice of 4 attractive lacquered finishes. Optional display panel.

#### Square shape

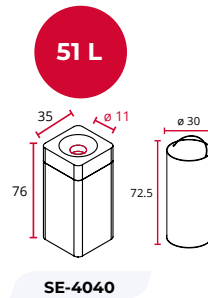

#### Quarter shape

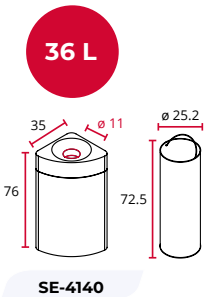

#### Display panels

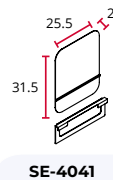

Check out these containers as waste sorting combinations [page 32](#)

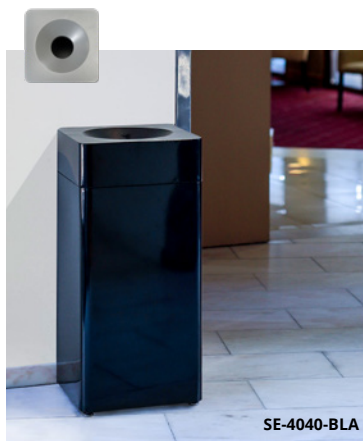





## OPEN DOME Epoxy

Ideal for shops, entrances, halls or washrooms.

Neat appearance and high-quality finish. Wide openings for fast, hygienic waste disposal. Removable lid for quick access to bag. Protected base.

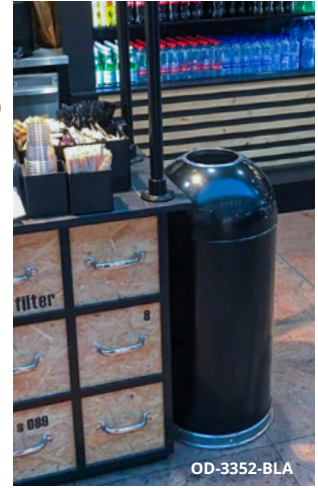

## PUSH BINS Epoxy • Stainless steel 430 & 304

An attractive solution for waste collection.

The push-lid waste bin is a classic piece of equipment in commercial and office environments. This model features a silent, spring-loaded stainless steel flap and a bag holder to keep waste out of sight. A rubber ring around the bottom edge protects the floor from scratches and the bin from chemicals.



# ROUND CONTAINERS



Polypropylene

## Robust, easy-to-move containers.

Solid construction with reinforced edges and bottom, for indoor or outdoor use. Clip-on lids allow containers to be stacked high. Integrated handles make handling easy and allow containers to be nested without jamming. Lids and wheeled bases are practical accessories to meet every need. Temperature resistance -29°C to +60°C.



\* Food contact approved containers except black containers and platform trolley

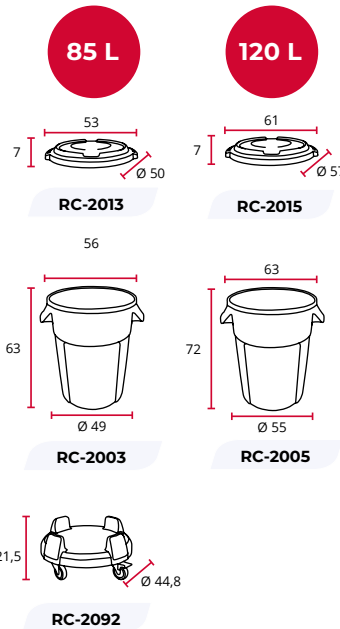

Stackable and nestable



The base of the container snaps onto the platform trolley. 2 positions: **85L or 120L**







## Selective Waste collection

### 28-29. Specific collection ↓

- Transparent containers
- Cups collectors
- Bio waste containers

### 30-31. Sorting bins 2 or 3 streams ↕ ↗

### 32-33. Lobby bins 🏠

### 34-37. MIX & MATCH SYSTEM

- Inserts, lid frames and bins **A B C** 🏠
- Lids for recycling bins
- Accessories

### 38-39. Step-on containers

### 40. Round containers



# SPECIFIC COLLECTION



## TRANSPARENT CONTAINERS **PMMA** ↓

**Perfect for collection of recyclables anywhere.**

Perfect for collecting small recyclables. Collection of batteries, telephones, glasses, donations etc. Opening dimensions: 11 x 3.8 cm. Padded bottom to reduce noise when items are dropped. Lockable with key included. Small model for a counter or shelf. Large model ideal free standing on the floor. Made from recyclable PMMA (Plexiglas).



BR-0025-CLR BR-0075-CLR

BR-0025

BR-0075

**INCLUDED**

Sorting stickers included  
**page 54**

STICKER-SHEET4

BR-0025-CLR

## CUP COLLECTORS **Epoxy** ↓ ↕

**Efficient cup collection in attractive containers.**

Ideal for collecting plastic or paper cups next to coffee machines, in conference rooms or break-out areas. The cups are deposited directly into the tubes attached to the lid. For cups up to 8 cm in diameter. 2 models available: cups only or combined cups and waste bin.

PB-3142-BLA PB-3143-BLA

**+60%**  
The cups stack automatically inside the tubes.

Attach one or two waste bags to the bag holder.

PB-3142-BLA

PB-3142

PB-3143

NEW

## BIO-WASTE COLLECTORS

70% Recycled polypropylene ↓

### Hygienic collection of food scraps.

Small volumes for transporting bio-waste to the collection point. With handle for easy transport. Lightweight, compact and robust, made from recycled material. Dishwasher safe.

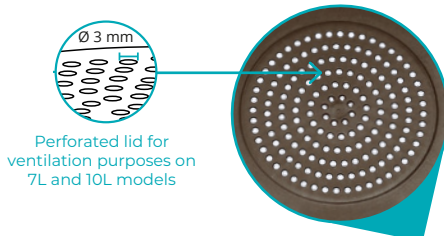

7 L

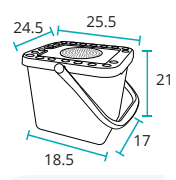

CB-0307

10 L

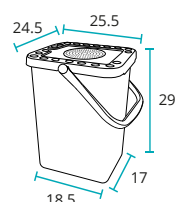

CB-0310

20 L

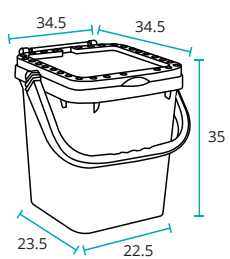

CB-0320



Stackable.  
Hinged handle locks lid in closed position



Handle and hinged lid on all models



## STEP ON CONTAINERS FOR BIOWASTE COLLECTION.



NEW

	BASE	LID	COMBINAISON
30 L	-DGRY (50% recycled)	-BRN	SO-1230-DBRN
	-GRY	-BRN	SO-1230-GBRN
	-WHT	-BRN	SO-1230-WBRN
45 L	-DGRY (50% recycled)	-BRN	SO-1245-DBRN
	-GRY	-BRN	SO-1245-GBRN
	-WHT	-BRN	SO-1245-WBRN
70 L	-DGRY (50% recycled)	-BRN	SO-1270-DBRN
	-GRY	-BRN	SO-1270-GBRN
	-WHT	-BRN	SO-1270-WBRN
90 L	-DGRY (50% recycled)	-BRN	SO-1290-DBRN
	-GRY	-BRN	SO-1290-GBRN
	-WHT	-BRN	SO-1290-WBRN



Antibacterial step ons  
page 22

Details and full range  
page 38-39

-BRN BROWN -DGRY DARK GREY -GRY GREY -WHT WHITE

# SORTING BINS

## 2 OR 3 COMPARTMENTS Epoxy/PP • Stainless steel 201/PP

### A compact sorting solution.

Ideal for hotels and offices, this bin can be used to sort 2 or 3 types of small waste. Waste is identified by applying stickers to the bin handles. 6 stickers supplied with each bin.

### 2 STREAMS

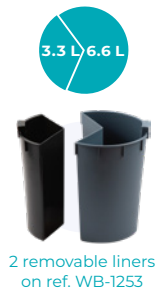
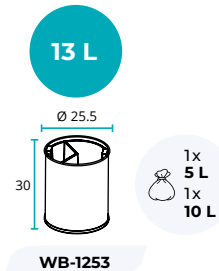
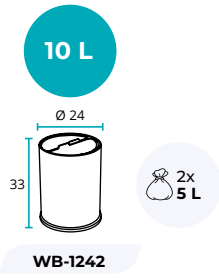

### 3 STREAMS - COLOURED LINERS

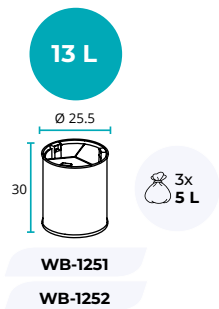

### 3 STREAMS - BLACK LINERS



See all sorting stickers  
page 54

INCLUDED  
WB-1242-BLA  
WB-1253  
STICKER-SHEET2

INCLUDED  
WB-1242-BLA  
STICKER-SHEET7



## WASTE SEPARATION BINS WITH LID

Epoxy • Stainless steel 430



### Efficient 3-stream waste sorting solution.

This original Probbax® design enables selective waste collection in conference rooms, offices, break rooms, etc. Available in 2 capacities and 2 finishes, the collectors come with 3 galvanised inner bins, easily removable using an integrated handle.

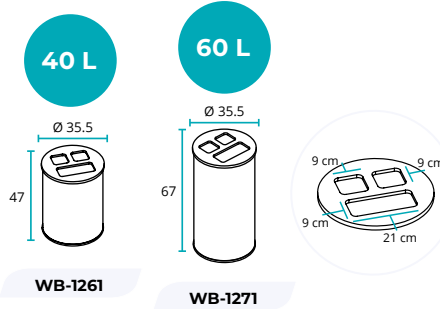

STICKER-SHEET3



Waste identification on lid with pictogram and/or colour stickers



WB-1271-BLA

## SLIM CONTAINERS Polypropylene ↓

### Multi-purpose containers for narrow spaces.

These containers can be used with or without swing lid. They are easy to place under a desk or countertop. See pages 18-19 for a wall mounted version sold as a kit.

#### Lids

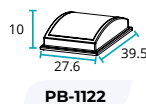

#### Bin



#### Full kits



50% RECYCLED black container

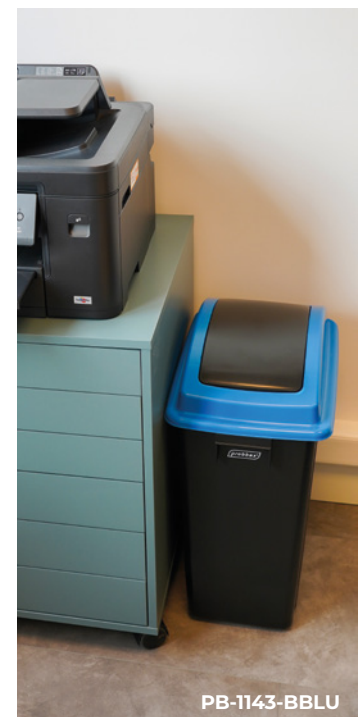

PB-1143-BBLU



# LOBBY BINS

## MODULAR FIRE-RESISTANT Epoxy • Stainless steel 201

Stylish containers in quarter-moon or square shapes.

To be combined according to the space available, the number of streams required, and to be complemented by display panels for communicating sorting instructions.



SE-4040



SE-4140

**FIRE-RESISTANT**  
TÜV Fireproof  
certification  
 V2 certification



## EXAMPLES OF WASTE STATION COMBINAISONS

### Corner combinaisons

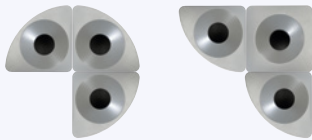

### Island combinaisons

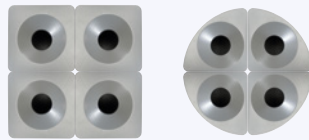

### In line combinaisons



**123 L**  
Total volume



**72 L**  
Total volume



**138 L**  
Total volume



See page 24  
for all codes and details

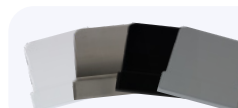

Display panels codes and details  
page 24

**OPEN DOME RECEPTACLES** Stainless steel 430 & 201 ↓ 

**A durable, attractive solution to simplify waste sorting in the workplace.**

The large top opening allows waste to be quickly dropped in the bin. The coloured lids are varnished for an attractive finish. Colours can be chosen individually to match an interior or combined to create a waste sorting station.

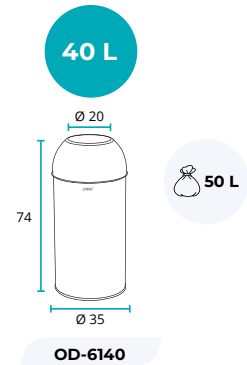

Break room



Conference room



Lobby

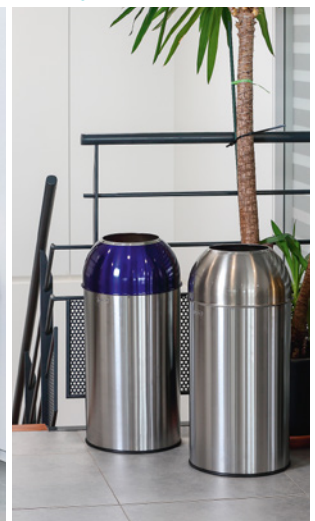

See black and white versions in the Indoor waste section **page 25**



# MIX & MATCH SYSTEM

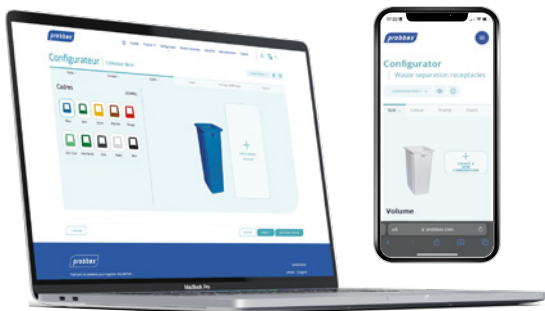

Create and visualise your customised recycling station with our online configurator at

[WWW.PROBBAX.COM](http://WWW.PROBBAX.COM)

**A** INSERTS  
Page 35

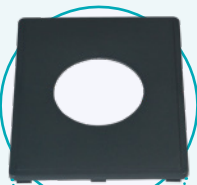

“Click”

**B** LID FRAMES  
Page 35



**STICKERS**  
Page 35 and 55

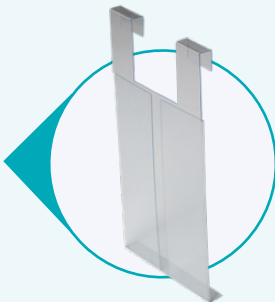

**DISPLAYS**  
and poster configurator  
Page 37



**DOLLIES**  
and accessories  
Page 36



**C** CONTAINERS  
Page 35

### A INSERTS

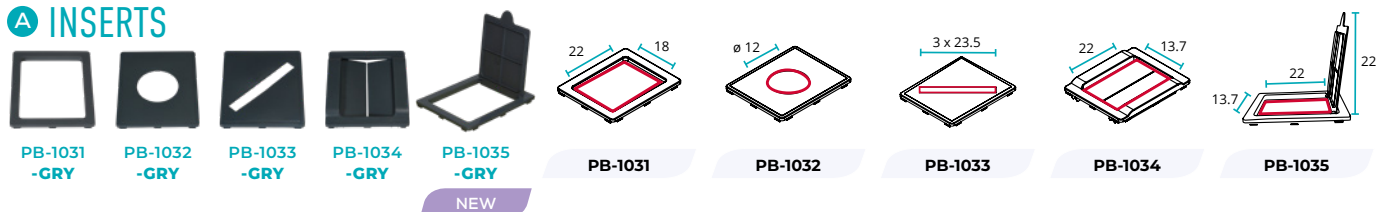

### B LID FRAMES 60 L - 80 L



### SORTING STICKERS

INCLUDED

Associate a type of waste to the frame + insert combination of your choice. Each frame is delivered with a set of 6 stickers.



STICKER-SHEET1

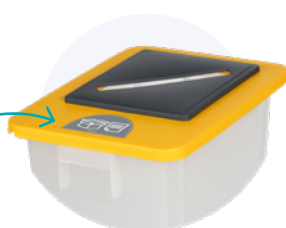

NEW COLOUR and NEW INSERT compatible with bio waste collection



See next page for more lids compatible with waste separation receptacles

### C CONTAINERS



\* Black containers composed of at least 50% recycled material.

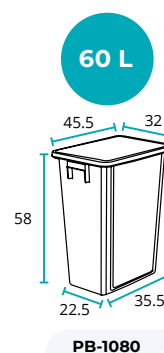

\* Black containers composed of at least 50% recycled material.

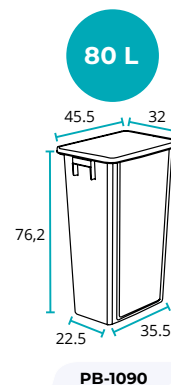

50% RECYCLED  
Black version made of at least 50% recycled material

See page 42 the white and transparent versions as food approved ingredients bins

### COLOUR REFERENCES

-BLA BLACK -BLU BLUE -BRN BROWN -CLR CLEAR -DGN DARK GREEN -GRN GREEN -GRY GREY -LGN LIGHT GREEN -ORA ORANGE -PUR PURPLE -RED RED -WHT WHITE -YEL YELLOW



Bags sizes compatibility p. 55

www.probbax.com

# LIDS FOR WASTE SEPARATION RECEPTACLES

## FLAT LIDS Polypropylene

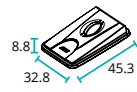

**PB-1011**

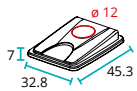

**PB-1012**

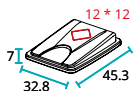

**PB-1013**

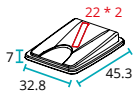

**PB-1014**



Side view

## DOME & PUSH LIDS Polypropylene

### Polypropylene



**PB-1081-GRY-LID**

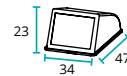

**PB-1081**



**PB-1021-GRY** **PB-1021-WHT**

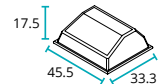

**PB-1021**



See full kits of wall-mounted containers with push lid and wall brackets **page 20**

## MIX & MATCH ACCESSORIES

### WALL-MOUNTING SET

#### Epoxy

Set composed of a bracket and screws.

All waste separation receptacles and lids are compatible with wall-mounting.



**PB-1005-DGRY**

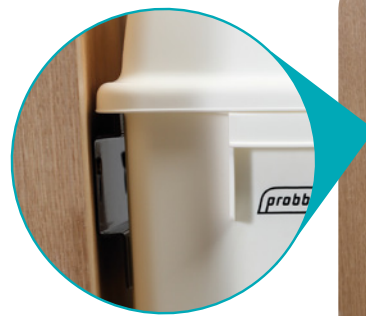
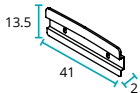

See page 20 complete sets of wall-mounted containers with lid and brackets

### DOLLIES

#### Polypropylene/Epoxy

Link dollies to create a mobile waste station.

Dollies available in plastic or metal/ Easy transportation of full containers to larger collection points. Fitted with swivel wheels (2 with breaks on PB-1001-BLA). Dollies loading capacity: 80kg.



**PB-1001-BLA** **PB-1002-BLA**

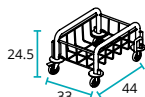

**PB-1001**

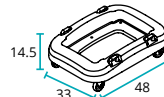

**PB-1002**





## CONNECTORS

Stainless steel

Keep the bins in place with connectors.

A set of 2 connectors to link the containers to each other and to securely keep them in place. Connectors are compatible with the use of lids.



## LOCKING KIT

Epoxy

Locking system to prevent access to critical waste.

Two-part locking kit to be fitted to the front and rear of the collector. Key AT-0200-KEY included.



Front



Back



## DISPLAY PANELS

PMMA • PVC

The displays help to emphasise **sorting instructions** and encourage good practices. Both displays fit an A4 sheet of paper, fit 60L and 80L receptacles and are compatible with the use of lids.

## POSTER CONFIGURATOR



Clear instructions for effective sorting at the source: Design and print your A4 posters in just a few clicks on [www.probbax.com](http://www.probbax.com)



PB-1008-CLR PB-1009-CLR



PB-1009

The hanging display lies on the rim of the container, to the front or to the side



PB-1008

The upright display mounts onto the handle of the container. Mounting kit included.



# SORTING STICKERS FOR WASTE SEPARATION RECEPTACLES AND STEP-ON CONTAINERS

Associate a type of waste to a coloured lid of choice. Each bin/lid is delivered with a set of 6 sorting stickers. More details about all stickers available [page 54](#).

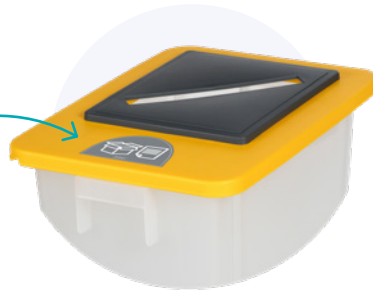

## PEDAL BINS

Polypropylene ↓



**Ideal for hands-free refuse disposal.**

Probbax® pedal bins enable efficient waste separation in the workplace. 4 sizes of sturdy, easy-to-maintain bins are available in solid or two-tone colours. A pack of 6 selective sorting stickers is supplied with each bin.

### FULL COLOURS



### DUAL COLOURS



### AVAILABLE SIZES

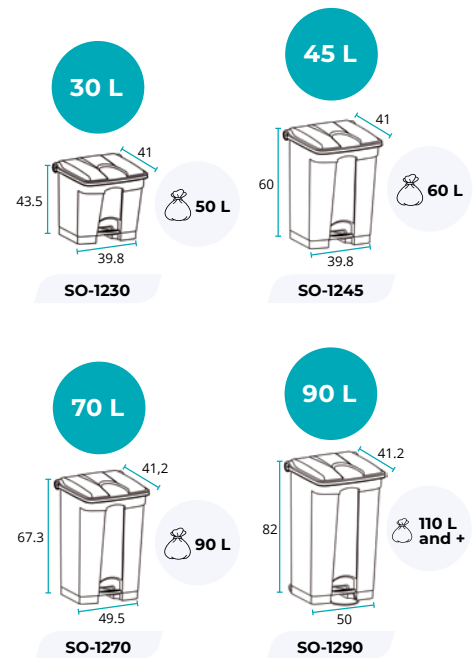

### PRODUCT CODES BREAKDOWN

**EXAMPLE OF SO-1230-WBLU**

**SO-12** **30** - **W** **BLU**

ROOT VOLUME BASE COLOUR LID COLOUR



### COLOUR REFERENCES

-BLA BLACK -BLU BLUE -BRN BROWN -GRN GREEN -DGRY DARK GREY -GRY GREY -RED RED -WHT WHITE -YEL YELLOW

## FULL COLOURS



## DUAL COLOUR - WHITE BASE



## DUAL COLOUR- GREY BASE



## DUAL COLOUR- 50% RECYCLED DARK GREY BASE\*



\*Dark grey base contains up to 50% recycled plastics.





# ROUND CONTAINERS

Polypropylene ↓



## Sturdy, easy-to-move containers.

Solid construction with reinforced edges and base, for indoor or outdoor use. Clip-on lids allow containers to be stacked. Large handles make handling easy and allow containers to be nested without jamming. Lids and wheeled bases are practical accessories to meet every need. Temperature resistance -29°C to +60°C.

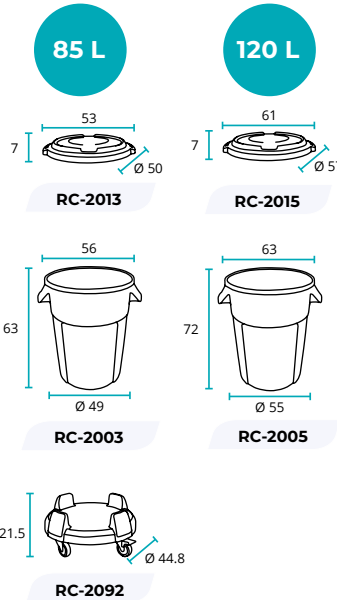



## Food service Equipment

### 42. Ingredient bins

- Space saving containers
- Round containers

### 43-44. Waste collectors

- Bag holder
- Pedal bins

# INGREDIENT BINS



## SPACE SAVING CONTAINERS Polypropylene

**For use in commercial kitchens and food preparation areas.**

Kit composed of food contact approved white or clear bin, clear lid and a transport dolly (they can be linked to each other). Available in either 60L or 80L, the bins can hang against the wall when using the wall-mounting support ref. PB-1005 [page 20](#).

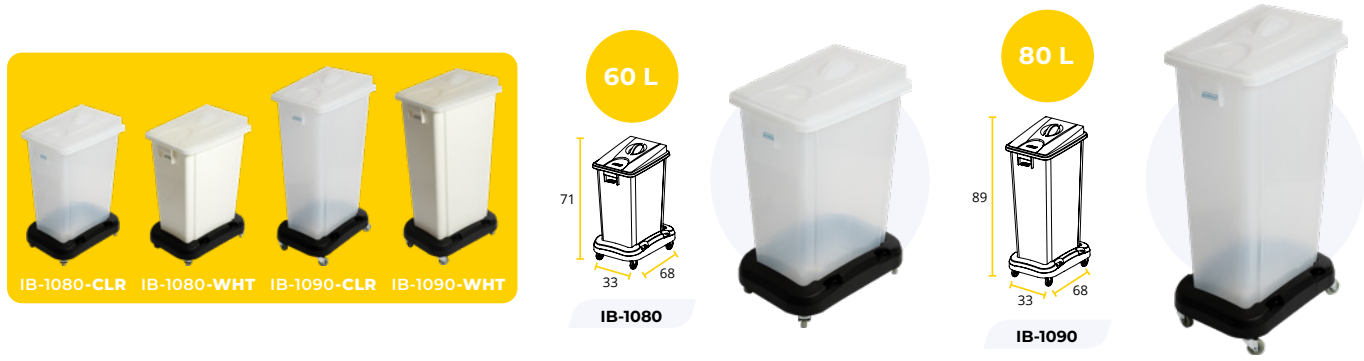

## ROUND CONTAINERS Polypropylene

**To store and transport larger volumes of foods.**

Soft-grip built in handles. Containers are stackable (without lids) and nestable (when used with lids). Platform dolly adapts to both container sizes.



More colours [page 26](#)





# WASTE COLLECTORS

## BAG HOLDER Stainless steel 201/Stainless steel 304



HACCP  
COMPLIANT

**A lightweight, robust and efficient solution.**

Appreciated for their ease of use and maintenance. Particularly suitable for food preparation areas.

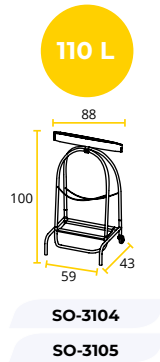
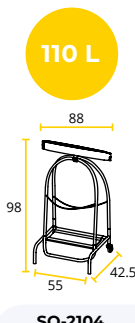

SO-3104 & SO-3105 made of 304 stainless steel and fitted with 8cm diameter rubber wheels

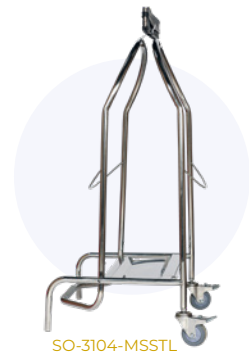

## PEDAL BINS Polyethylene/Polypropylene

**Container approved for food contact, very popular in professional kitchens. (EN840)**

Large metal pedal accessible from all angles. Optimised handling and transport thanks to large wheels and rear handle. The large wheels and rear handle make it easy to manoeuvre and transport. Durable plastic and metal construction resists impacts, stains and temperatures ranging from -60° C to + 120° C\*.

\* If stored at -60°C, wait for the collector to return to room temperature before use.

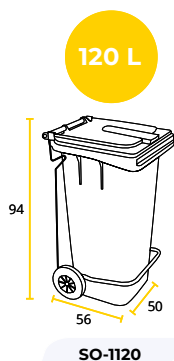



HACCP COMPLIANT

## Polypropylene

### A must-have in the catering industry.

Durable, hygienic and efficient. Silent opening and robust foot pedal. Wide lid to contain odours.

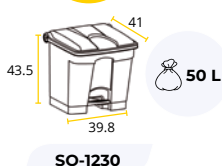

SO-1230

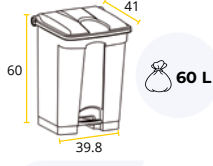

SO-1245

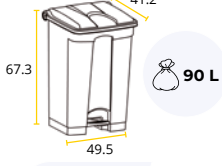
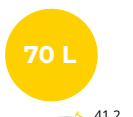

SO-1270

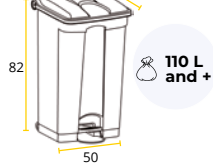
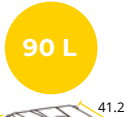

SO-1290



Wide, comfortable opening. Front ring for greater stability on the 90 L version



90 L container fitted with rear wheels for easy transport



Robust pedal mechanism for touch-free operation

## SORTING STICKERS INCLUDED

Match a type of waste sticker to the lids. Each collector comes with a set of 6 stickers. See all sorting stickers on **page 54**



More pedal bins colour variants **page 38**



Antibacterial step on bins **page 22**



## Sanitary Equipment

**46.** Paper dispensers

**46.** Hygiene bin

**47.** Toilet brushes

**48.** Floor signs

**48.** Dust pan



# PAPER DISPENSERS

## HANDKERCHIEF DISPENSER Stainless steel 430

Accommodates one standard-sized tissue box (+/- 100 tissues). Easy reloading and maintenance. Stainless steel with mirror finish. Wall-mountable with mounting hardware included.

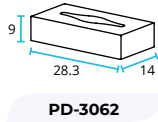

## FOR ROLLS Epoxy • Stainless steel 430

The dispensers accommodate jumbo rolls of 400 or 200 m. Smooth surface easy to clean and maintain. Powder coated steel parts (in and outside) are protected against rust. Visual check on paper reserve. Integrated keylock to prevent theft. Vandal-proof sturdy construction. Available in white epoxy or satin stainless steel. Wall-mounting hardware and template included.

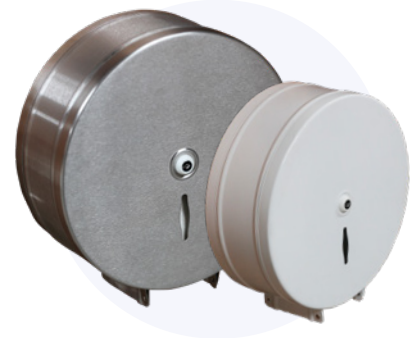
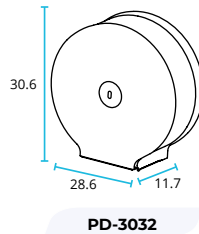
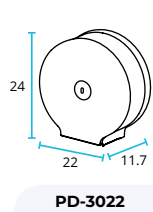

Easy reloading and maintenance



Diameter of mandrel: 43 mm (delivered with adaptor to fit larger rolls)



Serrated blades for an easy cutting of the paper on the right or left

## HYGIENE BIN

**ABS**



Pedal bin for sanitary protection with a capacity of 20L. Made of robust ABS. For use in away-from-home washrooms. Smooth, easy-to-clean surfaces. Slim design fits easily between a wall and the toilet bowl.

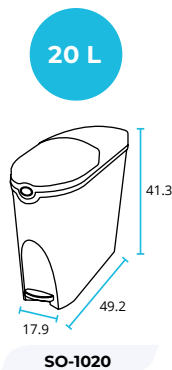

Wide, pedal-operated opening for hand-free waste disposal



Removable bag holder inside for easy emptying

# TOILET BRUSHES

Epoxy • Stainless steel 430

Toilet brush sets free standing or for wall mounting (screws included). Brushes fitted with exchangeable classic black vinyl brush heads except for TB-1005-SSSTL (silicone bristles).

## FREE STANDING

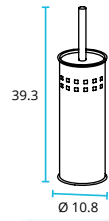

TB-1002

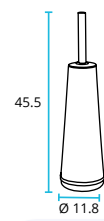

TB-1005



Brush with silicone bristles

## WALL-MOUNTED

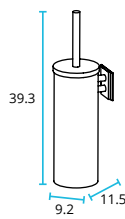

TB-2002

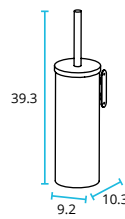

TB-2003



## COLOUR REFERENCES

-MBLA MAT BLACK -MSSTL STAINLESS STEEL MIRROR -SSSTL STAINLESS STEEL

## MAT BLACK ASSORTED PRODUCTS



Wall-mounted bins  
page 8

Pedal bins  
page 21

Open Dome bins  
page 25

## STAINLESS STEEL ASSORTED PRODUCTS



Pedal bins  
page 21

Paper dispensers  
page 46

Open Dome bins  
page 33

Modular bins  
page 24

# FLOOR SIGNS

## Polypropylene

### Make a strong statement about safety.

Very efficient to draw the attention of the passers-by to the risks of accident during the operations of cleaning or maintenance. Warning message printed on both sides.



FS-1001-YEL



FS-1011-YEL



FS-1012-YEL



FS-1013-YEL



FS-1014-YEL



FS-1015-YEL



FS-1016-YEL

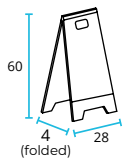

FS-10XX



Foldable in order to optimise storage space

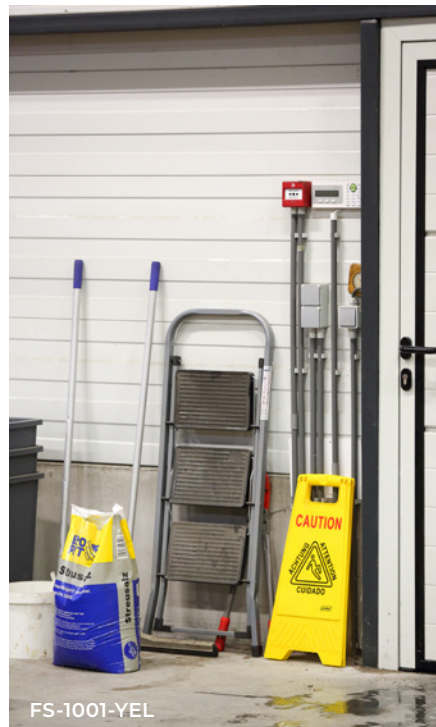

FS-1001-YEL

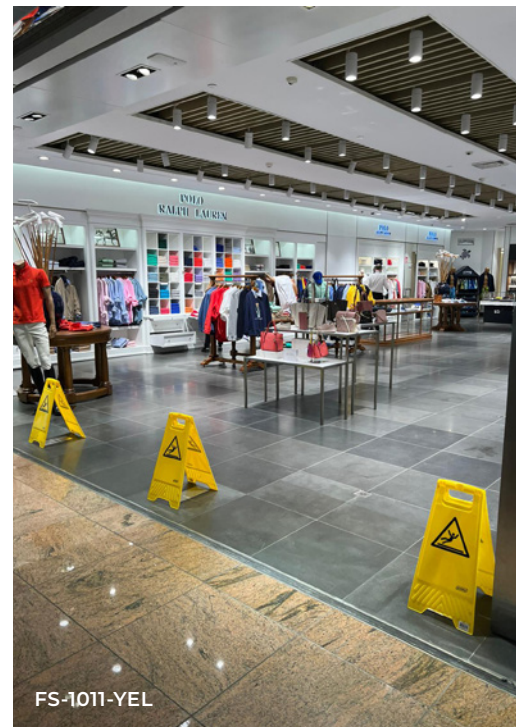

FS-1011-YEL

# DUST BIN

## Polypropylene/Aluminium

Dustbin with integrated wheels. • Wide opening • Ergonomic handle equipped with a hook to attach a broom (not included)  
• Space saving upright closed position.



DP-1010-BLA

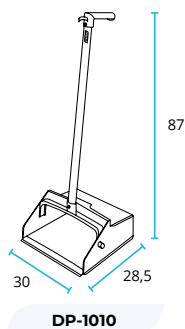

DP-1010



Plastic edge preventing marks on the ground.



View of the wheels at the rear, in upright position



INDEX														Page	INDEX
Item Code	EAN Code	Single unit box size in cm			Outer carton size in cm			Carton volume in m3	Quantity per carton Unit	N.W Kg/Unit	G.W Kg/Unit	Customs Duties HS Code			
		L	W	H	L	W	H								
AT-0030-ALU	4895238701838				26.0	6.5	3.3	0.001	10	0.05	0.06	76151090	5		
AT-0101-BLA	4897020620204	11.5	11.5	15.0	25.0	36.5	17.0	0.015	6	0.36	0.59	73239900	6		
AT-0102-BLA	4897020620167	16.5	17.0	18.5	51.0	18.0	40.0	0.037	6	0.93	1.12	73239900			
AT-0202-DGRY	4897020620617	16.5	7.5	26.7	36.0	26.0	29.0	0.027	6	2.13	2.33	73239900			
AT-0202-SSSTL	4897020629597	16.5	7.5	26.7	36.0	26.0	29.0	0.027	6	1.65	2.30	73239900			
AT-0210-DGRY	4897020626329	11.0	22.0	97.0	35.0	46.0	99.0	0.159	6	3.60	4.60	73239900			
AT-0212-DGRY	4897020626336	12.0	8.0	53.0	26.0	26.0	55.0	0.037	6	2.85	3.10	73239900			
AT-0212-SSSTL	4897020629603	12.0	8.0	53.0	26.0	26.0	55.0	0.037	6	2.40	3.58	73239900			
AT-0213-DGRY	4897020629658							0.033	1	6.45	7.70	73239900		11	
AT-0213-SSDG	4897020629665							0.033	1	6.00	8.18	73239900			
AT-0222-DGRY	4897020620624	20.5	7.5	36.2	44.0	26.0	38.5	0.044	6	3.51	3.85	73239900	6		
AT-0232-DGRY	4897020622598	0.0	0.0	0.0	0.0	0.0	0.0	0.112	2	16.83	18.98	73239900	11		
AT-0232-DGRY-BASE	4897020620716	42.0	28.0	8.0	44.0	30.0	18.5	0.024	2	6.90	8.00	73239900			
AT-0232-DGRY-BODY	4897020620723	22.0	17.0	102.5	45.5	18.5	104.5	0.088	2	9.93	10.98	73239900			
AT-0233-DGRY	4897020624400				34.0	28.0	103.0	0.098	1	15.80	17.30	73239900	13		
AT-0234-DGRY	4897020624417				52.0	28.0	103.0	0.150	1	23.10	25.10	73239900			
AT-0252-DGRY	4897020625704				31.0	17.0	70.0	0.037	1	10.20	11.00	73239900	8		
AT-0262-DGRY	4897020625957							0.112	2	16.20	17.50	73239900	12		
AT-0262-DGRY-BASE	4897020622536	42.0	28.0	8.0	44.0	30.0	18.5	0.024	2	6.90	8.00	73239900			
AT-0262-DGRY-BODY	4897020622529	22.0	17.0	102.5	45.5	18.5	104.5	0.088	2	9.30	9.50	73239900			
AT-0291-DGRY	4897020624264	13.5	13.0	56.0	29.0	29.0	60.0	0.050	4	3.00	3.20	73239900	7		
AT-0291-MSSTL	4897020629245	13.5	13.0	56.0	29.0	29.0	60.0	0.050	4	2.00	2.40	73239900			
AT-0292-DGRY	4897020625964							0.066	2	11.00	12.00	73239900	10		
AT-0292-DGRY-BASE	4897020622482	34.5	34.5	8.5	35.5	35.5	20.0	0.025	2	6.50	6.75	73239900			
AT-0292-DGRY-BODY	4897020622475	13.5	11.0	108.5	30.0	12.5	109.0	0.041	2	4.50	5.25	73239900			
AT-0292-MSSTL	4897020629269							0.066	2	9.80	10.80	73239900			
AT-0292-MSSTL-BASE	4897020629283	34.5	34.5	8.5	35.5	35.5	20.0	0.025	2	5.30	5.55	73239900			
AT-0292-MSSTL-BODY	4897020629290	13.5	11.0	108.5	30.0	12.5	109.0	0.041	2	4.50	5.25	73239900			
AT-0292-WORA	4895238701579							0.066	2	11.00	12.00	73239900			
AT-0292-WORA-BASE	4895238701586	34.5	34.5	8.5	35.5	35.5	20.0	0.025	2	6.50	6.75	73239900			
AT-0292-WORA-BODY	4895238701609	13.5	11.0	108.5	30.0	12.5	109.0	0.041	2	4.50	5.25	73239900			
AT-0295-DGRY	4895238702026				86.0	35.0	17.0	0.051	1	7.50		73239900	9		
AT-0295-DSTL	4895238702033				86.0	35.0	17.0	0.051	1	7.50		73239900			
AT-0295-SSSTL	4895238702040				86.0	35.0	17.0	0.051	1	7.50		73239900			
AT-0296-BLA	4895238702057				35.0	35.0	7.0	0.009	1	4.50		73239900			
AT-0303-ALU	4897020629795	12.0	9.0	41.0	44.0	39.5	23.0	0.040	6	0.85	1.16	76151090	7		
AT-0325-ALU	4895238700046							0.015	1	3.10	4.20	76151090	10		
AT-0325-ALU-BASE	4897020629801	31.5	31.5	6.5	32.5	32.5	28.5	0.030	4	1.10	1.63	76151090			
AT-0325-ALU-BODY	4897020629818	12.0	9.5	99.0	27.0	21.0	101.5	0.057	4	2.00	2.57	76151090			
AT-0403-MSSTL	4895238700282	13.0	10.0	48.5	33.0	29.0	52.0	0.050	6	1.13	1.53	73239900	7		
AT-0423-MSSTL	4895238700299				21.0	21.0	98.0	0.043	1	6.10	7.60	73239900	10		
AT-0990-DGRY	4897020629399				40.0	37.0	46.0	0.068	1	3.37	4.14	39269090	5.11		
AT-1271-DGRY	4897020622581				36.0	31.5	92.5	0.105	1	13.70	15.20	73239900	13		
AT-1272-DGRY	4897020624899				27.0	32.0	98.0	0.085	1	14.10	15.60	73239900			
AT-1273-DGRY	4897020624905				27.0	50.0	98.0	0.132	1	18.30	20.30	73239900			
AT-2030-BLA	4897020620181				27.0	27.0	72.0	0.052	1	3.50	4.54	73239900	12		
AT-2030-SSSTL	4897020620655				27.0	27.0	72.0	0.052	1	3.20	4.30	73239900			
BH-5000	4895238703207								1			39269090	16		
BH-5001	4895238703214								5			39269090			
BH-5002	4895238703221											39269090			
BH-5003	4895238703238											39269090			
BH-5005	4895238703245											39269090			
BH-5008	4895238703160											39269090			
BR-0025-CLR	4897020626022	36.0	36.0	35.0	75.0	38.0	72.5	0.207	4	1.30	1.50	39269050	28		
BR-0075-CLR	4897020626039	36.0	36.0	84.0	75.0	38.0	86.5	0.247	2	2.70	4.00	39269050			

Item Code	EAN Code	Single unit box size in cm			Outer carton size in cm			Carton volume in m3	Quantity per carton Unit	N.W Kg/Unit	G.W Kg/Unit	Customs Duties HS Code	Page
		L	W	H	L	W	H						
CB-0307-BRN	4895238701913									0.39		39269050	29
CB-0310-BRN	4895238701661									0.46		39269050	
CB-0320-BRN	4895238701920									1.10		39269050	
DP-1010-BLA	4897020624684				90.0	37.0	30.5	0.102	6	1.10	1.23	39269050	48
FR-1002-BLA	4897020620525				50.0	37.0	42.5	0.079	20	0.58	0.63	39269050	18
FR-1003-BLA	4897020620532				58.0	42.0	51.0	0.120	20	0.85	0.90	39269050	
FR-1112-DGRY	4895238700169				50.0	37.0	42.5	0.079	20	0.58	0.63	39269050	
FR-1113-DGRY	4895238700183				58.0	42.0	51.0	0.120	20	0.85	0.90	39269050	
<b>FS-10xx</b>					31.5	28.5	64.0	0.057	10	0.65	0.74	39269050	48
FS-1001-YEL	4897020620396	FS-1012-YEL	4897020625766	FS-1014-YEL	4897020625780	FS-1016-YEL	4897020625803						
FS-1011-YEL	4897020625759	FS-1013-YEL	4897020625773	FS-1015-YEL	4897020625797								
IB-1080-CLR	4895238700244								1	4.17		87168000	42
IB-1080-WHT	4895238700251								1	4.17		87168000	
IB-1090-CLR	4895238700268								1	4.97		87168000	
IB-1090-WHT	4895238700275								1	4.97		87168000	
OD-3352-BLA	4897020622277				42.0	42.0	101.0	0.178	1	6.8	10.00	73239900	25
<b>OD-6140</b>					38.0	38.0	72.5	0.105	1	3.30	4.70	73239900	25.33
OD-6140-MBLA	4895238700695	OD-6140-SGRN	4897020626404	OD-6140-SSSTL	4897020626428	OD-6140-WHT	4895238700701						
OD-6140-SBLU	4897020626398	OD-6140-SRED	4897020626411	OD-6140-SYEL	4897020626435								
PB-1000-BLA	4897020624523	19.0	4.0	6.5	49.0	22.5	22.5	0.030	30	0.22	0.25	73239900	37
PB-1001-BLA	4897020624271	41.5	33.5	17.5	69.5	43.5	56.5	0.167	6	2.95	4.23	87168000	36
PB-1002-BLA	4897020624912	49.0	16.0	36.0	100.0	51.0	39.0	0.199	6	1.67	2.30	87168000	20.36
PB-1005-DGRY	4897020626138	43.0	4.0	13.5	45.0	15.0	21.0	0.014	15	1.65	2.00	73239900	
PB-1006-SSSTL	4897020627975	10.0	15.0	26.0	21.0	20.5	0.011	50	0.10	0.12	73239900	37	
PB-1008-CLR	4897020629474	4.8	23.5	46.0	50.0	25.5	47.5	0.061	10	0.73	1.00		39269090
PB-1009-CLR	4897020629481	3.2	22.5	41.0	42.0	34.0	24.0	0.034	10	0.18	0.38		39269050
PB-1011-CLR	4895238700053				46.5	44.0	33.5	0.068	6	0.53	0.63	39269050	36
PB-1011-GRY	4897020624288				46.5	44.0	33.5	0.068	6	0.50	0.65	39269050	
PB-1012-BLU	4897020624875				46.5	31.0	33.5	0.048	6	0.46	0.58	39269050	
PB-1012-GRN	4897020624295				46.5	31.0	33.5	0.048	6	0.46	0.58	39269050	
PB-1013-YEL	4897020624301				46.5	31.0	33.5	0.048	6	0.46	0.58	39269050	
PB-1014-BLU	4897020624318				46.5	31.0	33.5	0.048	6	0.46	0.58	39269050	
PB-1014-YEL	4897020625100				46.5	31.0	33.5	0.048	6	0.46	0.58	39269050	
PB-1021-GRY	4897020626015				33.5	36.5	47.0	0.057	10	0.57	0.63	39269050	
PB-1021-WHT	4897020626930				33.5	36.5	47.0	0.057	10	0.57	0.63	39269050	
<b>PB-1030</b>	<i>Per 10:</i>	<i>46.0</i>	<i>34.0</i>	<i>24.0</i>	48.0	36.0	50.0	0.09	Per 20	0.26	0.43	39269050	
PB-1030-BLA	4897020627807	PB-1030-DGN	4897020627920	PB-1030-LGN	4897020627937	PB-1030-RED	4897020627845						
PB-1030-BLU	4897020627814	PB-1030-GRN	4897020627821	PB-1030-ORA	4897020627968	PB-1030-WHT	4897020627944						
PB-1030-BRN	4897020627913	PB-1030-GRY	4897020627838	PB-1030-PUR	4895238701739	PB-1030-YEL	4897020627852						
PB-1031-GRY	4897020627869	<i>29.0</i>	<i>24.0</i>	<i>19.0</i>	50.0	31.0	40.0	0.062	40	0.10	0.15	39269090	35
PB-1032-GRY	4897020627876	<i>29.0</i>	<i>24.0</i>	<i>17.0</i>	50.0	31.0	36.0	0.056	40	0.16	0.21	39269090	
PB-1033-GRY	4897020627883	<i>29.0</i>	<i>24.0</i>	<i>17.0</i>	50.0	31.0	36.0	0.056	40	0.18	0.23	39269090	
PB-1034-GRY	4897020627890	<i>29.0</i>	<i>24.0</i>	<i>40.5</i>	50.0	31.0	42.5	0.066	20	0.64	0.81	39269090	
PB-1035-GRY	4895238701883	<i>30.5</i>	<i>23.0</i>	<i>24.0</i>	49.0	32.5	26.0	0.041	10	0.25	0.35	39269090	
<b>PB-1080</b>					46.0	32.5	106.0	0.16	6	2.00	2.85	39269050	35
PB-1080-BLA	4897020626893	PB-1080-GRN	4897020626916	PB-1080-WHT	4897020626947								
PB-1080-BLU	4897020626909	PB-1080-GRY	4897020620549	PB-1080-YEL	4897020629535								
PB-1080-CLR	4897020629412				48.5	33.5	132.0	0.214	6	2.00	2.85	39269050	35
PB-1081-GRY-LID	4897020620556				53.0	35.5	53.0	0.100	10	0.62	0.79	39269050	36
<b>PB-1090</b>					46.0	32.5	126.0	0.188	6	2.80	3.22	39269050	35
PB-1090-BLA	4897020626442	PB-1090-GRN	4897020626466	PB-1090-WHT	4897020626954								
PB-1090-BLU	4897020626459	PB-1090-GRY	4897020622932	PB-1090-YEL	4897020627951								
PB-1090-CLR	4897020629429				46.5	32.5	150.5	0.227	6	2.80	3.22	39269050	35
PB-1105-DGRY	4897020626961	13.5	3.5	29.0	43.0	20.0	32.0	0.028	15	1.10	1.33	73239900	19.20

Item Code	EAN Code	Single unit box size in cm			Outer carton size in cm			Carton volume in m3	Quantity per carton Unit	N.W Kg/Unit	G.W Kg/Unit	Customs Duties HS Code	Page
		L	W	H	L	W	H						
PB-1121-GRY	4897020627012				40.5	28.5	34.0	0.039	10	0.49	0.59	39269050	19
PB-1121-WHT	4897020627029				40.5	28.5	34.0	0.039	10	0.49	0.59	39269050	
PB-1122-BLA	4895238700060				43.0	28.5	38.0	0.047	10	0.36	0.48	39269050	19.31
PB-1122-BLU	4895238700077				43.0	28.5	38.0	0.047	10	0.36	0.48	39269050	
PB-1122-YEL	4895238700084				43.0	28.5	38.0	0.047	10	0.36	0.48	39269050	
<b>PB-1140</b>					40.5	28.5	84.0	0.096	6	1.28	1.53	39269050	
<b>PB-1140-BLA</b>	4895238700091	<b>PB-1140-GRY</b>	4897020627036	<b>PB-1140-WHT</b>				4897020627043					
PB-1142-GRY	4897020627715									2.87		39269050	31
PB-1142-WHT	4897020627739									2.87		39269050	
PB-1143-BBLU	4895238700114									1.64		39269050	
PB-1143-BLA	4895238700107									1.64		39269050	
PB-1143-BYEL	4895238700121									1.64		39269050	20
PB-1280-GRY	4897020627630									4.14	5.44	39269050	
PB-1280-WHT	4897020627654									4.14	5.44	39269050	
PB-1290-GRY	4897020627678									4.94	5.81	39269050	
PB-1290-WHT	4897020627692									4.94	5.81	39269050	25
PB-1320-WHT	4897020629825				35.0	25.0	67.5	0.591	5	1.07	1.20	39269050	
PB-1321-WHT	4895238700237									2.17		39269050	
PB-3140-BLA	4897020620143				37.0	37.0	73.0	0.100	1	5.20	7.29	73239900	
PB-3140-MSSTL	4897020620150				37.0	37.0	73.0	0.100	1	4.80	6.80	73239900	28
PB-3142-BLA	4897020629320				43.0	43.0	72.0	0.133	1	7.20	9.20	73239900	
PB-3143-BLA	4897020629337				43.0	43.0	72.0	0.133	1	6.80	8.80	73239900	46
PD-3022-SSSTL	4897020622369	27.8	13.0	26.0	53.0	47.5	25.7	0.065	8	1.20	1.43	73249000	
PD-3022-WHT	4897020620402	27.8	13.0	26.0	53.0	47.5	25.7	0.065	8	1.30	1.53	73249000	
PD-3032-SSSTL	4897020622376	30.0	30.0	12.7	61.0	53.0	31.5	0.103	8	1.65	1.95	73249000	
PD-3032-WHT	4897020620419	30.0	30.0	12.7	61.0	53.0	31.5	0.103	8	1.75	2.11	73249000	
PD-3062-MSSTL	4897020622420	29.5	14.4	7.0	37.5	31.0	60.5	0.070	20	0.86	0.99	73249000	
<b>RC-2003</b>									1	2.10	2.10	39269090	26.40.42
<b>RC-2003-BLA</b>	4897020625186	<b>RC-2003-BLU</b>	4897020625193	<b>RC-2003-GRY</b>	4897020625216		<b>RC-2003-WHT</b>	4897020625230					
<b>RC-2005</b>									1	3.10	3.10	39269090	
<b>RC-2005-BLA</b>	4897020625254							<b>RC-2005-GRY</b>	4897020625278		<b>RC-2005-WHT</b>	4897020625292	
<b>RC-2013</b>					51.0	51.0	17.0	0.044	4	0.65	0.91	39269090	
<b>RC-2013-BLA</b>	4897020625315							<b>RC-2013-GRY</b>	4897020625339		<b>RC-2013-WHT</b>	4897020625353	
<b>RC-2015</b>					59.0	59.0	16.0	0.056	6	1.28	1.53	39269050	24.32
<b>RC-2015-BLA</b>	4897020625377							<b>RC-2015-GRY</b>	4897020625391		<b>RC-2015-WHT</b>	4897020625414	
RC-2025-GRY	4897020625438				59.0	59.0	16.0	0.056	2	0.82	1.30	39269090	
RC-2092-BLA	4897020625445				44.8	44.8	21.5	0.043	1	3.31	4.01	87168000	
SE-4040-BLA	4897020626213				38.5	38.5	79.0	0.117	1	14.50	16.00	73239900	46
SE-4040-SIL	4897020626237				38.5	38.5	79.0	0.117	1	14.50	16.00	73239900	
SE-4040-SSSTL	4897020626220				38.5	38.5	79.0	0.117	1	12.50	14.00	73239900	
SE-4040-WHT	4897020626244				38.5	38.5	79.0	0.117	1	14.50	16.00	73239900	
SE-4041-BLA	4897020626299	29.0	3.5	35.0	38.0	38.0	31.0	0.045	10	1.60	2.10	73239900	
SE-4041-SIL	4897020626312	29.0	3.5	35.0	38.0	38.0	31.0	0.045	10	1.60	2.10	73239900	
SE-4041-SSSTL	4897020626305	29.0	3.5	35.0	38.0	38.0	31.0	0.045	10	1.60	2.10	73239900	
SE-4041-WHT	4897020626923	29.0	3.5	35.0	38.0	38.0	31.0	0.045	10	1.60	2.10	73239900	
SE-4140-BLA	4897020626251				38.5	38.5	79.0	0.117	1	13.00	14.50	73239900	
SE-4140-SIL	4897020626275				38.5	38.5	79.0	0.117	1	13.00	14.50	73239900	
SE-4140-SSSTL	4897020626268				38.5	38.5	79.0	0.117	1	11.20	12.50	73239900	
SE-4140-WHT	4897020626282				38.5	38.5	79.0	0.117	1	13.00	14.50	73239900	
SO-1020-WHT	4895238701937				49.5	35.5	84.5	0.148	4	1.77		39269050	46
SO-1120-WHT	4897020629641				55.0	51.0	95.0	0.266	1	10.30	12.40	87168000	23.43
<b>SO-1230 BASES</b>					40.0	38.5	87.0	0.13	8	1.64	1.81	39269050	22.38.39
<b>SO-1230-BLA-BASE</b>	4897020629894	<b>SO-1230-GRY-BASE</b>	4897020623410		<b>SO-1230-WHT-BASE</b>			4897020623427					
<b>SO-1230-DGRY-BASE</b>	4895238700893	<b>SO-1230-RED-BASE</b>	4897020624165		<b>SO-1230-YEL-BASE</b>			4897020624370					



Item Code	EAN Code	Single unit box size in cm			Outer carton size in cm			Carton volume	Quantity per carton	N.W	G.W	Customs Duties	Page
		L	W	H	L	W	H	in m3	Unit	Kg/Unit	Kg/Unit	HS Code	
<b>SO-1230 ASSEMBLED</b>					42.5	42.0	45.5	0.081	1	2.19	2.51	39269050	
SO-1230-BLA	4897020629962	SO-1230-DYEL	4895238700916			SO-1230-GYEL	4897020623014			SO-1230-WHT	4897020622635		
SO-1230-DBLU	4895238700848	SO-1230-GBLU	4897020622987			SO-1230-RED	4897020624820			SO-1230-WRED	4897020623052		
SO-1230-DBRN	4895238700855	SO-1230-GBRN	4895238700923			SO-1230-WBLU	4897020623021			SO-1230-WYEL	4897020623069		
SO-1230-DGRN	4895238700862	SO-1230-GGRN	4897020622994			SO-1230-WBRN	4895238700930			SO-1230-YEL	4897020622642		
SO-1230-DGRY	4895238700886	SO-1230-GRED	4897020623007			SO-1230-WDGR	4895238701623						
SO-1230-DRED	4895238700879	SO-1230-GRY	4897020622628			SO-1230-WGRN	4897020623038						
SO-1230-DWHT	4895238700909	SO-1230-GWHT	4897020625971			SO-1230-WGRY	4897020623045						
<b>SO-1245 BASES</b>					40.0	38.5	117.0	0.180	8	2.10	2.31	39269050	
SO-1245-BLA-BASE	4897020629900	SO-1245-GRY-BASE	4897020623441			SO-1245-WHT-BASE	4897020623458						
SO-1245-DGRY-BASE	4895238701005	SO-1245-RED-BASE	4897020624172			SO-1245-YEL-BASE	4897020624202						
<b>SO-1245 ASSEMBLED</b>					42.5	42.0	62.0	0.111	1	2.65	3.01	39269050	
SO-1245-BLA	4897020629979	SO-1245-DYEL	4895238701036			SO-1245-GYEL	4897020623106			SO-1245-WHT	4897020622673		
SO-1245-DBLU	4895238700954	SO-1245-GBLU	4897020623076			SO-1245-RED	4897020624837			SO-1245-WRED	4897020623144		
SO-1245-DBRN	4895238700961	SO-1245-GBRN	4895238701043			SO-1245-WBLU	4897020623113			SO-1245-WYEL	4897020623151		
SO-1245-DGRN	4895238700978	SO-1245-GGRN	4897020623083			SO-1245-WBRN	4895238701050			SO-1245-YEL	4897020622680		
SO-1245-DGRY	4895238700992	SO-1245-GRED	4897020623090			SO-1245-WDGR	4895238701630						
SO-1245-DRED	4895238700985	SO-1245-GRY	4897020622666			SO-1245-WGRN	4897020623120						
SO-1245-DWHT	4895238701029	SO-1245-GWHT	4897020625988			SO-1245-WGRY	4897020623137						
<b>LIDS for SO-1230 + SO-1245</b>					52.0	42.0	42.0	0.092	8	0.55	0.70	39269050	
SO-1245-BLA-LID	4897020629917	SO-1245-DGRY-LID	4895238701012			SO-1245-WHT-LID	4897020623519						
SO-1245-BLU-LID	4897020623472	SO-1245-GRN-LID	4897020623489			SO-1245-RED-LID	4897020623496						
SO-1245-BRN-LID	4895238700947	SO-1245-GRY-LID	4897020623502			SO-1245-YEL-LID	4897020623526						
<b>SO-1270 BASES</b>					49.0	40.0	120.0	0.235	6	3.50	3.87	39269050	
SO-1270-BLA-BASE	4897020629924	SO-1270-GRY-BASE	4897020623540			SO-1270-WHT-BASE	4897020623557						
SO-1270-DGRY-BASE	4895238701104	SO-1270-RED-BASE	4897020624189			SO-1270-YEL-BASE	4897020623991						
<b>SO-1270 ASSEMBLED</b>					52.2	43.0	69.8	0.157	1	4.33	4.93	39269050	
SO-1270-BLA	4897020629986	SO-1270-DYEL	4895238701128			SO-1270-GYEL	4897020623199			SO-1270-WHT	4897020622697		
SO-1270-DBLU	4895238701067	SO-1270-GBLU	4897020623168			SO-1270-RED	4897020624844			SO-1270-WRED	4897020623236		
SO-1270-DBRN	4895238701210	SO-1270-GBRN	4895238701227			SO-1270-WBLU	4897020623205			SO-1270-WYEL	4897020623243		
SO-1270-DGRN	4895238701074	SO-1270-GGRN	4897020623175			SO-1270-WBRN	4895238701234			SO-1270-YEL	4897020620877		
SO-1270-DGRY	4895238701098	SO-1270-GRED	4897020623182			SO-1270-WDGR	4895238701647						
SO-1270-DRED	4895238701081	SO-1270-GRY	4897020620693			SO-1270-WGRN	4897020623212						
SO-1270-DWHT	4895238701111	SO-1270-GWHT	4897020625995			SO-1270-WGRY	4897020623229						
<b>SO-1290 BASES</b>					49.0	40.0	142.5	0.279	6	4.30	4.73	87168000	
SO-1290-BLA-BASE	4897020629931	SO-1290-GRY-BASE	4897020623571			SO-1290-WHT-BASE	4897020623588						
SO-1290-DGRY-BASE	4895238701173	SO-1290-RED-BASE	4897020624196			SO-1290-YEL-BASE	4897020624387						
<b>SO-1290 ASSEMBLED</b>					52.2	43.0	84.5	0.190	1	5.13	5.80	87168000	
SO-1290-BLA	4897020624363	SO-1290-DYEL	4895238701203			SO-1290-GYEL	4897020623304			SO-1290-WHT	4897020623342		
SO-1290-DBLU	4895238701135	SO-1290-GBLU	4897020623267			SO-1290-RED	4897020624851			SO-1290-WRED	4897020623359		
SO-1290-DBRN	4895238701258	SO-1290-GBRN	4895238701265			SO-1290-WBLU	4897020623311			SO-1290-WYEL	4897020623366		
SO-1290-DGRN	4895238701142	SO-1290-GGRN	4897020623274			SO-1290-WBRN	4895238701272			SO-1290-YEL	4897020624868		
SO-1290-DGRY	4895238701166	SO-1290-GRED	4897020623281			SO-1290-WDGR	4895238701654						
SO-1290-DRED	4895238701159	SO-1290-GRY	4897020623298			SO-1290-WGRN	4897020623328						
SO-1290-DWHT	4895238701197	SO-1290-GWHT	4897020626008			SO-1290-WGRY	4897020623335						
<b>LIDS for SO-1270 + SO-1290</b>					54.0	44.0	44.0	0.105	6	0.83	1.07	39269050	
SO-1290-BLA-LID	4897020629948	SO-1290-DGRY-LID	4895238701180			SO-1290-WHT-LID	4897020623649						
SO-1290-BLU-LID	4897020623601	SO-1290-GRN-LID	4897020623618			SO-1290-RED-LID	4897020623625						
SO-1290-BRN-LID	4895238701241	SO-1290-GRY-LID	4897020623632			SO-1290-YEL-LID	4897020623656						
SO-2104-MSSTL	4897020624219		72.0	56.0	19.0	0.077	1	5.50	6.90	87168000			
SO-3104-MSSTL	4895238701753		72.0	56.0	19.0	0.077	1	4.80	6.20	87168000		23.433	
SO-3105-MSSTL	4897020629436		72.0	56.0	19.0	0.077	1	6.30	7.70	87168000			
SO-6003-MBLA	4897020624929	18.5	18.5	28.3	57.5	39.0	30.0	0.067	6	0.78	1.35	73239900	
SO-6003-MSSTL	4897020620051	18.5	18.5	28.3	57.5	39.0	30.0	0.067	6	0.78	1.35	73239900	21

Item Code	EAN Code	Single unit box size in cm			Outer carton size in cm			Carton volume in m3	Quantity per carton Unit	N.W Kg/Unit	G.W Kg/Unit	Customs Duties HS Code	Page
		L	W	H	L	W	H						
SO-6003-WHT	4897020620044	18.5	18.5	28.3	57.5	39.0	30.0	0.067	6	0.78	1.35	73239900	21
SO-6005-MBLA	4897020625032	23.5	22.5	29.5	49.0	47.0	32.0	0.074	4	0.91	1.86	73239900	
SO-6005-MSSTL	4897020620075	23.5	22.5	29.5	49.0	47.0	32.0	0.074	4	0.91	1.86	73239900	
SO-6005-WHT	4897020620068	23.5	22.5	29.5	49.0	47.0	32.0	0.074	4	1.06	1.86	73239900	
SO-6012-MSSTL	4897020620099	26.5	26.0	40.5	54.0	28.0	42.5	0.064	2	1.80	2.99	73239900	
SO-6012-WHT	4897020620082	26.5	26.0	40.5	54.0	28.0	42.5	0.064	2	1.82	2.99	73239900	
SO-6020-MSSTL	4897020620884	31.0	30.5	45.8	63.0	32.5	48.0	0.098	2	2.43	3.40	73239900	
SO-6020-WHT	4897020622192	31.0	30.5	45.8	63.0	32.5	48.0	0.098	2	2.43	3.40	73239900	
SO-6030-MBLA	4897020626985	31.0	31.5	66.0	33.5	33.0	67.5	0.075	1	3.70	4.80	73239900	
SO-6030-MSSTL	4897020620891	31.0	31.5	66.0	33.5	33.0	67.5	0.075	1	3.50	5.00	73239900	
SO-6030-WHT	4897020622505	31.0	31.5	66.0	33.5	33.0	67.5	0.075	1	3.70	4.80	73239900	
SO-6205-SSSTL	4897020627906	26.0	26.0	33.8	57.0	57.0	35.0	0.102	4	1.04	1.78	73239900	
ST-0210-GRY	4895238700312				26.5	20.0	63.0	0.033	6	0.41		39269050	19
ST-0210-WHT	4895238700343				26.5	20.0	63.0	0.033	6	0.41		39269050	
ST-0225-GRY	4895238700374				34.5	26.0	72.0	0.065	5	0.81		39269050	
ST-0225-WHT	4895238700404				34.5	26.0	72.0	0.065	5	0.81		39269050	
ST-0250-GRY	4895238700435				40.0	30.0	73.5	0.088	4	1.39		39269050	
ST-0250-WHT	4895238700466				40.0	30.0	73.5	0.088	4	1.39		39269050	
<b>SORTING STICKERS</b>												49111090	54
<b>STICKER-SHEET1</b>	4895238700558	<b>STICKER-SHEET3</b>	4895238701784		<b>STICKER-SHEET7</b>	4895238701876							
<b>STICKER-SHEET2</b>	4895238701760	<b>STICKER-SHEET4</b>	4895238701791										
TB-1002-SSSTL	4897020624691	10.5	10.5	28.0	44.0	33.0	58.0	0.084	24	0.41	0.53	96039099	47
TB-1005-SSSTL	4897020629443	12.3	12.3	33.5	51.0	38.5	35.0	0.069	12	0.63	0.77	96039099	
TB-2002-SSSTL	4897020624967	12.5	10.0	27.5	30.0	30.0	44.0	0.040	12	0.70	0.88	96039099	
TB-2003-MBLA	4897020629634	9.5	9.5	27.5	40.0	30.0	28.5	0.034	12	0.70	0.88	96039099	
TB-2003-MSSTL	4897020625537	9.5	9.5	27.5	40.0	30.0	28.5	0.034	12	0.70	0.88	96039099	19
WB-0125-GRY	4897020626343				25.0	34.0	65.0	0.055	6	0.66		39269090	19
WB-1042-BLA	4897020624936	25.5	25.5	30.5	53.0	53.0	32.5	0.091	4	1.10	1.65	73239900	18
WB-1042-BRN	4897020624943	25.5	25.5	30.5	53.0	53.0	32.5	0.091	4	1.10	1.65	73239900	
WB-1051-BEI	4897020620907	26.0	26.0	29.0	53.0	53.0	31.0	0.087	4	1.80	2.30	73239900	
WB-1051-BLA	4897020620433	26.0	26.0	29.0	53.0	53.0	31.0	0.087	4	1.80	2.30	73239900	
WB-1051-SSSTL	4897020620914	26.0	26.0	29.0	53.0	53.0	31.0	0.087	4	1.80	2.30	73239900	
WB-1242-BLA	4895238701951	26.5	26.5	35.0	53.0	53.0	38.0	0.107	4	2.00	2.75	73239900	30
WB-1251-BLA	4897020624424	26.5	26.5	32.5	56.0	56.0	35.0	0.110	4	2.36	2.90	73239900	
WB-1251-SSSTL	4897020624431	26.5	26.5	32.5	56.0	56.0	35.0	0.110	4	2.36	2.90	73239900	
WB-1252-BLA	4897020624516	26.5	26.5	32.5	56.0	56.0	35.0	0.110	4	2.36	2.90	73239900	
WB-1252-SSSTL	4897020624509	26.5	26.5	32.5	56.0	56.0	35.0	0.110	4	2.36	2.90	73239900	
WB-1253-BLA	4897020629511	26.5	26.5	32.5	56.0	56.0	35.0	0.110	4	2.00	2.50	73239900	
WB-1253-SSSTL	4897020629528	26.5	26.5	32.5	56.0	56.0	35.0	0.110	4	2.00	2.50	73239900	
WB-1261-BLA	4897020624707				36.5	36.5	48.0	0.064	1	5.30	6.80	73239900	31
WB-1261-SSSTL	4897020624714				36.5	36.5	48.0	0.064	1	5.30	6.80	73239900	
WB-1271-BLA	4897020624721				36.5	36.5	68.5	0.091	1	7.30	9.30	73239900	
WB-1271-SSSTL	4897020624738				36.5	36.5	68.5	0.091	1	7.30	9.30	73239900	
WM-3020-WHT	4897020627050				36.0	20.0	51.0	0.037	1	2.90	3.60	73239900	8.20
WM-3021-DGRY	4895238700817				36.0	20.0	51.0	0.037	1	2.90	3.60	73239900	
WM-3040-WHT	4897020627067				41.0	23.0	68.0	0.064	1	5.40	6.30	73239900	
WM-3041-DGRY	4895238700824				41.0	23.0	68.0	0.064	1	5.40	6.30	73239900	
WS-0101-SSSTL	4895238703177											73239900	15
WS-0102-SSSTL	4895238703184											73239900	
WS-0103-SSSTL	4895238703191											73239900	
WS-0112-CBLA	4895238700626								1	39.5		39249000	14.15
WS-0113-CBLA	4895238700633								1	56.5		39249000	
WS-0121-CBLA	4895238700640								1	29.0		39249000	

# SORTING STICKERS

## MIX & MATCH AND SO-12XX



WB-1251-1252-1253



WB-1261 AND WB-1271



BR Range



WB-10xx



STICKER-SHEET1

A4 - 220 X 310 mm

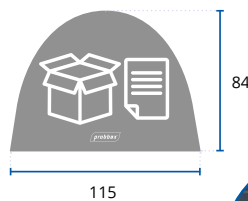

STICKER-SHEET2

A6 - 105 X 148 mm

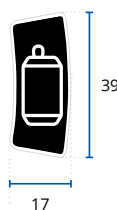

STICKER-SHEET3

A4 - 310 X 220 mm

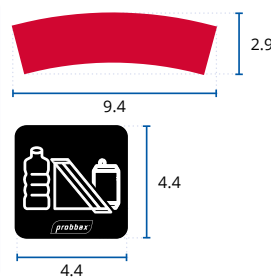

STICKER-SHEET4

A4 - 220 X 310 mm

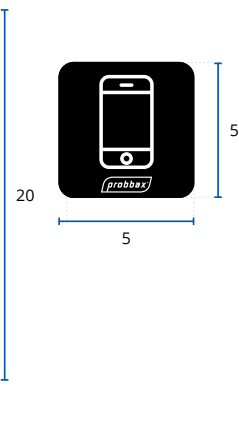
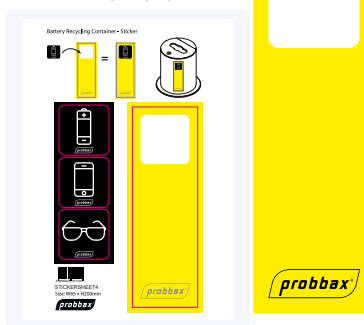

STICKER-SHEET7

A6 - 105 X 148 mm









# CONTAINERS AND WASTE BAGS COMPATIBILITY CHART

Item code	Container capacity (Liters)	Perimeter of Top opening or Liner	Waste bag minimum dimensions	
			Width	Height
FR-1002 / FR-1112	6L	105 cm	46 cm	53 cm
FR-1003 / FR-1113	13L	85 cm	54 cm	60 cm
PB-1140	40L	124 cm	72 cm	58 cm
PB-1080	60L	143 cm	83 cm	96 cm
PB-1090	80L			114 cm
PB-3140	40L	126 cm	63 cm	104 cm
PB-3142				
PB-3143				
OD-3352	52L	112 cm (Liner)	54 cm	101 cm
OD-6140	40L	101 cm	54 cm	60 cm
SE-4040	51L	96 cm	49 cm	84 cm
SE-4140	36L	81 cm		
SO-1120	120L	196 cm	200 cm	149 cm
SO-1230	30L	136 cm	86 cm	79 cm
SO-1245	45L			96 cm
SO-1270	70L	153 cm	96 cm	107 cm
SO-1290	90L			122 cm
SO-2104	110L	119 cm	103 cm	133 cm
SO-3104				
SO-3105				
SO-6003	3L	51 cm	27 cm	47 cm
SO-6005	5L	60 cm	31 cm	50 cm
SO-6012	12L	75 cm	39 cm	63 cm
SO-6020	20L	90 cm	46 cm	70 cm
SO-6030	30L			90 cm
ST-0210	10L	75 cm	49 cm	50 cm
ST-0225	25L	104 cm	67 cm	68 cm
ST-0250	50L	123 cm	80 cm	87 cm
WB-0125	25L	103 cm	81 cm	107 cm
WB-1042	10L	70 cm	35 cm	54 cm
WB-1051		71 cm		53 cm
WM-3020 / 3021	20L	95 cm	55 cm	82 cm
WM-3040 / 3041	40L	109 cm	63 cm	101 cm

## BINS WITH COMPARTMENTS

WB-1242	10L		2 x 5L waste bags
WB-1251	13L		3 x 5L waste bags
WB-1252			
WB-1253	13L		1 x 5L waste bag + 1 x 10L waste bag
WB-1261	40L		1 x 20L waste bag + 2 x 10L waste bags
WB-1271	60L		1 x 30L waste bag + 2 x 15L waste bags



Manufacturer of waste management solutions  
Fabricant de solutions pour la gestion des déchets  
Fabricante de soluciones para la gestión de residuos  
Hersteller von Abfalllösungen  
Fabrikant van afval oplossingen  
Fabbricante di soluzioni per la gestione dei rifiuti

## CURRENT DISTRIBUTION NETWORK

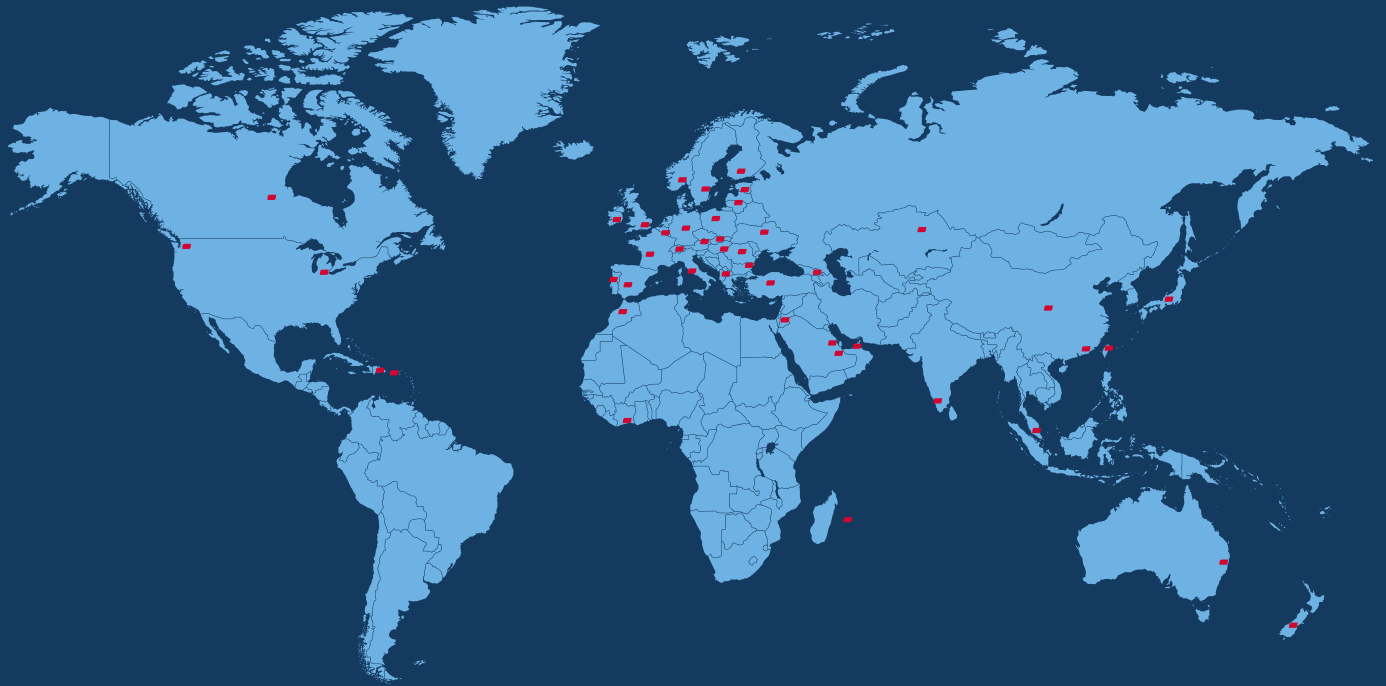

Contact us today and join the team of successful  
Probbax representatives in the world !



### Europe

17a rue des Tilleuls  
L-8832 Rombach  
Luxembourg  
info@probbax.com

### Asia Pacific

Office 1, Level 1, The Hive,  
33-35 Hillier Street,  
Sheung Wan  
Honk Kong SAR.  
info@probbax.com

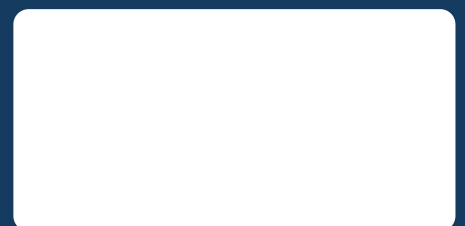

[WWW.PROBBAX.COM](http://WWW.PROBBAX.COM)